

BAB V

KESIMPULAN DAN SARAN

5.1 Kesimpulan

Berdasarkan hasil perencanaan redesain struktur gedung Hotel Lombok Astoria Mataram dengan menggunakan portal baja dan *cross bracing* dengan menganalisa menggunakan *software* SAP2000 v.14, Untuk analisa gaya dalamnya, maka kesimpulan yang didapatkan sebagai berikut:

1. Hasil analisa menunjukkan bahwa komponen struktur gedung dengan portal baja dan *cross bracing* yang direncanakan aman terhadap beban gempa.
2. Tebal plat lantai yang diperoleh 150 mm, dimana didapatkan untuk tulangan lapangan D12-325 mm, dan tulangan tumpuan D12-300 mm.
3. Dalam perencanaan, material baja yang digunakan BJ 55 dimana tegangan leleh (f_y) = 410 MPa, tegangan putus (f_u) = 550 MPa, dan modulus elastisitas baja (E_s) = 200000 MPa, Adapun profil baja yang digunakan pada struktur sebagai berikut:
 - a. Berdasarkan dari hasil perencanaan *bracing* konsentris digunakan profil WF 300.150.6.8 yang dipasang pada sisi luar gedung arah melintang dan memanjang.
 - b. Berdasarkan dari hasil perencanaan balok digunakan balok WF 500.300.11.18 untuk balok arah memanjang, dan profil WF 400.300.10.16 untuk balok arah melintang, yang dimana profil tersebut aman terhadap lendutan.
 - c. Berdasarkan hasil dari perencanaan kolom digunakan profil dengan dimensi yang berbeda untuk kolom lantai 1-4 digunakan profil KC 800.300.14.16, lantai 5-8 digunakan profil KC 700.300.13.24, lantai 9-11 menggunakan profil KC 600.200.11.17, yang dimana profil tersebut aman terhadap intraksi gaya aksial dan lentur.
 - d. Pada perencanaan sambungan digunakan baut mutu A325 dengan diameter $\frac{3}{4}$ in dengan kuat tarik (f_{ub}) = 620 MPa, dan kuat geser (f_{uv}) = 372 MPa.

4. Hasil perhitungan struktur bawah didapatkan dimensi kolom pedestal digunakan 1100 mm x 1100 mm dengan tulangan pokok 10D16 dan tulangan sengkang D10-250, Sedangkan pondasi menggunakan tiang pancang (*bored pile*) diameter 0,5 m dengan kedalaman 20,6 m, yang dimana menggunakan *pilecap* berdimensi 3,5 x 3,5 m dimana disetiap *pilecap* memiliki jumlah tiang sebanyak 9 tiang.

5.2 Saran

Berdasarkan hasil Analisa struktur gedung yang diredesain, maka saran yang bisa dilakukan untuk perencanaan selanjutnya adalah:

1. Dengan kemajuan teknologi modern, desain struktur portal baja dapat dianalisis menggunakan berbagai macam program seperti ETABS atau MIDAS, STAADPRO dengan tetap memperhatikan peraturan-praturan yang berlaku.
2. Dalam penelitian selanjutnya dapat dicoba menggunakan tipe *bracing* yang berbeda seperti tipe *K-Braced* dan *V-Braced*.

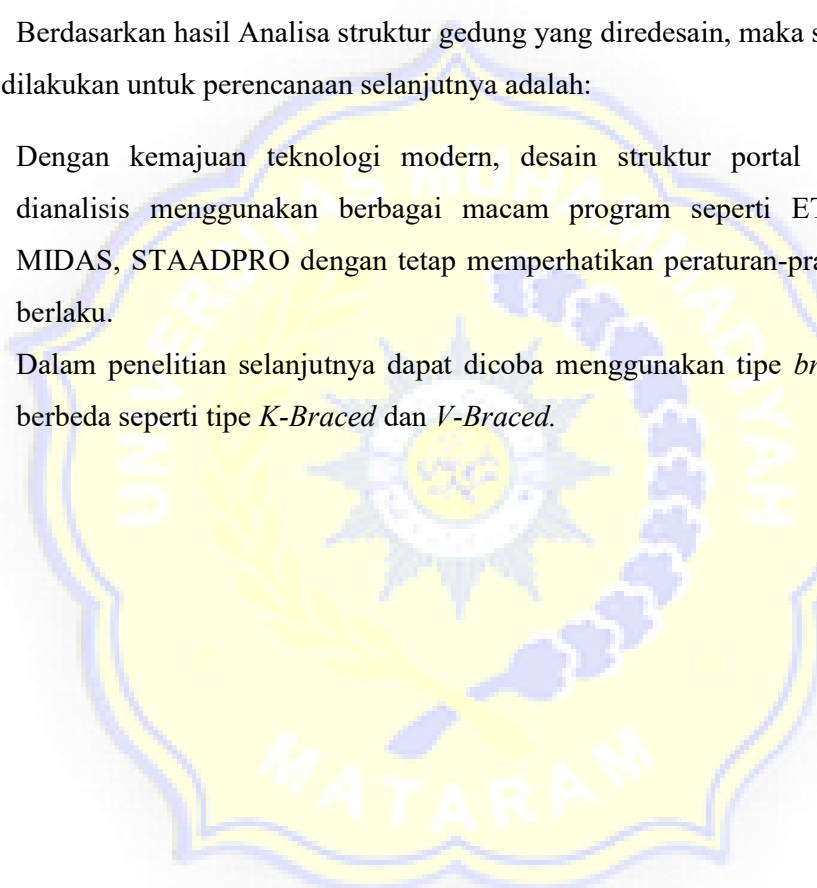

DAFTAR PUSTAKA

- ANSI/AISC 360-16 An American National Standard. (2016). *Specification for Structural Steel Buildings*. Chicago: Illinois 60601-6204.
- AISC, (2010). '*Specification for structural Steel building (ANSI/AISC 360-10)*'. Chicago: American Institute of Steel Construction.
- Ahmad, S. (2022). "*Redesain Struktur Gedung Hotel Golden Tulip Mataram Dengan Menggunakan Portal Baja Dan Bracing Diagonal*". Universitas Muhammadiyah Mataram.
- Badan Standardisasi Nasional. (2020). SNI 1729:2020 *Spesifikasi untuk bangunan gedung baja struktural (ANSI/AISC 360-16, IDT)*. Jakarta.
- Badan Standarisasi Nasional, (2019), SNI 1726:2019. *Tata Cara Perencanaan Ketahanan Gempa Untuk Bangunan Gedung dan Non Gedung*.
- Badan Standarisasi Nasional, (2019), SNI 2847:2019. *Persyaratan Beton Struktural Untuk Bangunan Gedung*.
- Badan Standarisasi Nasional. (2005). *Baja profil I-Beam proses canai panas (Bj.P I-Beam)*. Jakarta: Departemen Pekerjaan Umum.
- Dimas, H. P. (2022). "*Redesain Struktur Gedung Hotel Golden Tulip Mataram Dengan Menggunakan Portal Baja Dan Inverted-V Braced*". Universitas Muhammadiyah Mataram.
- Dewobroto, W. (2015). SNI 1729:2015 dan Era Baru Perencanaan Pupuk Berbasis Komputer. Dalam Seminar Nasional "*Inovasi Struktural dan Rekayasa Material dalam Teknologi Konstruksi*".
- Dewobroto, W. (2016). *Struktur Baja Perilaku, Analisis & Desain – AISC 2010*. Jakarta: Lumina Press.
- Direktorat Penyelidikan Masalah Bangunan. (1981). *Peraturan Pembebanan Indonesia untuk Gedung 1983*. Bandung: Stensil.
- Desain Spektra Indonesia. (2023, April 10). Retrieved from <https://rsa.ciptakarya.pu.go.id/2021/>.
- Gunawan, R. (1987). *Tabel Profil Konstruksi Baja*. Yogyakarta: Kansius.
- Hariyadi, (2023). *Data Tanah Hotel Lombok Astoria Mataram*. Mataram.
- Hardiyatmo, H. C. (2010). *Analisis dan Perancangan Fondasi*. Gadjah Mada University Press.
- Manaha, M. G. (2017). "*Studi Perencanaan Struktur Baja Menggunakan Bresing Konsentris Tipe X Pada Gedung Hotel Ijen Suites Malang*". ITN Malang.

- Nasional, B. S. (1983). *Peraturan Pembebanan Indonesia Untuk Gedung (PPIUG)*. Bandung: Yayasan Lembaga Penyelidikan Masalah Bangunan.
- Pamungkas, A & Harianti, E. (2013). *Desain Pondasi Tahan Gempa Sesuai SNI 03-1726-2002 dan SNI 03-2847-2002*. ANDI Yogyakarta. Yogyakarta.
- Panuluh, A. A. (2010). *Analisa Penggunaan Sistem Rangka Bracing Terhadap Perpindahan Lateral Portal Baja Bertingkat Tinggi*. Skripsi. Teknik Sipil. Universitas Muhammadiyah Mataram.
- Setiawan, A. (2008). *Perencanaan Struktur Baja Dengan Metode LRFD (Sesuai SNI 03-1729-2002)*. Jakarta.
- Standar Nasional Indonesia. (2002). *SNI 03-2847-2002 Tata Cara Perhitungan Struktur Beton Untuk Bangunan Gedung*. Bandung.
- Vis, W. C., & Gideon, H. K. (1993). *Dasar-dasar Perencanaan Beton Bertulang*. Jakarta.



LAMPIRAN 1

Desain Eksisting

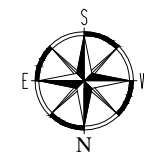
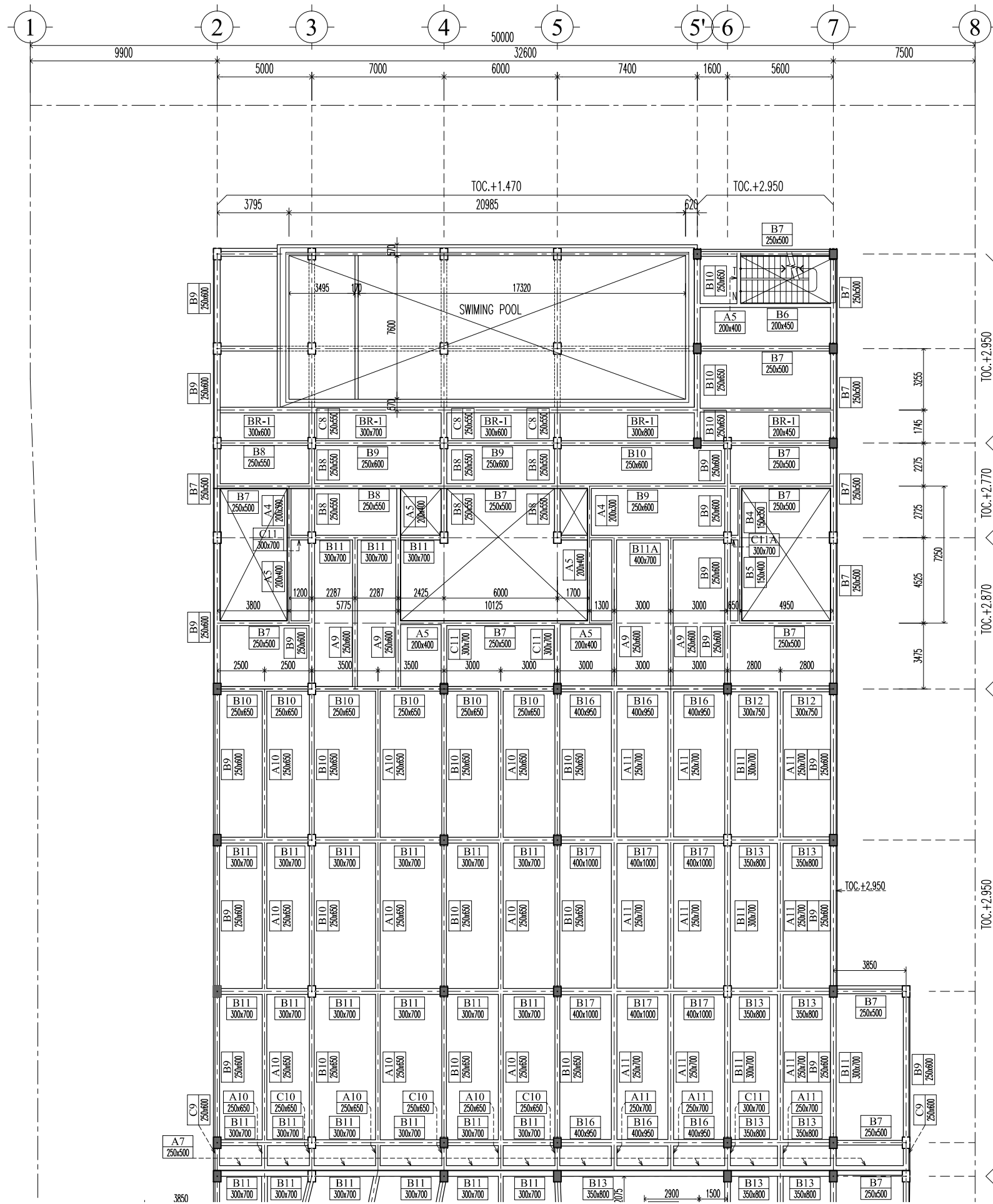

DENAH BALOK
LANTAI DASAR
SKALA 1:250

Notes :

0	Issued For Contructions	7/4/14
NO	REVISION	DATE SIGN

Key Plan :

Proyek :
Project
Hotel Arum Lombok

Pemberi Tugas :
Owner
PT. Mataram Andalas Semesta

APPROVAL :
BY OWNER
Ibu. Intan Fitrianti

Konsultan Arsitek :
Architect Consultant
PT. ARSITA INTERKREASI
ARCHITECTURE, INTERIOR, LANDSCAPE
JL. PULOMAS UTARA BID NO.1 PULOMAS - JAKARTA TIMUR
TELP (62-21) 4892635 47882346 47882313

Konsultan Interior :
Interior Consultant

Konsultan Struktur :
Konsultan Struktur
PT. ADINATA SURYA PRATAMA
ENGINEERING CONSULTANT
Ruko Paksi Blok F2 NO. 5A7 Bumi Anggrek Jl. Karangasari, Bekasi
Telp : (021) 82737860, 08138997677
E-mail : adinatas1@gmail.com, puspojono@yahoo.com

Konsultan M & E
M & E Consultant
PT. EMSE
KOMPLEK TAMAN KENCANA BLOK E1 NO.20
LINGKAR LUAR CENGKARENG, JAKARTA 11730

Judul gambar :
Drawing Title
DENAH BALOK
LANTAI DASAR

Drawn By	Putut	DATE	23/03/14
Job Captain		DATE	
Project Architect		DATE	
Project Manager		DATE	
Project Director		DATE	
OWNER APPROVAL		DATE	

SCALE 1 : 250

ISSUED FOR	REVISION	DRAWING CODE/NO
CONTRACT.	0	S-01.6B
DATE	7/4/14	

FILE :

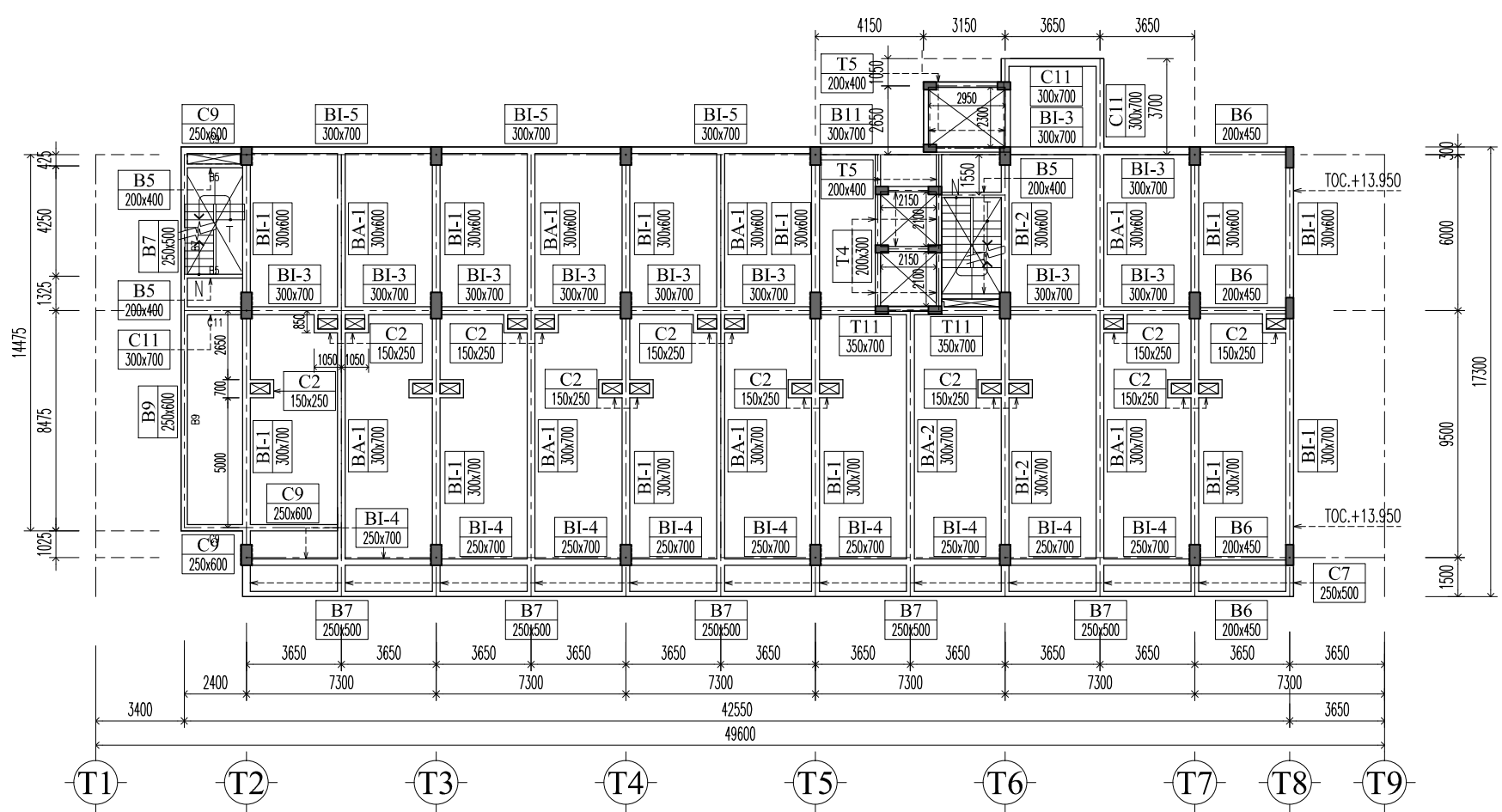
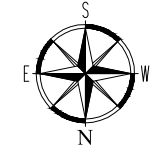

DENAH BALOK LT. - 3
SKALA 1:250

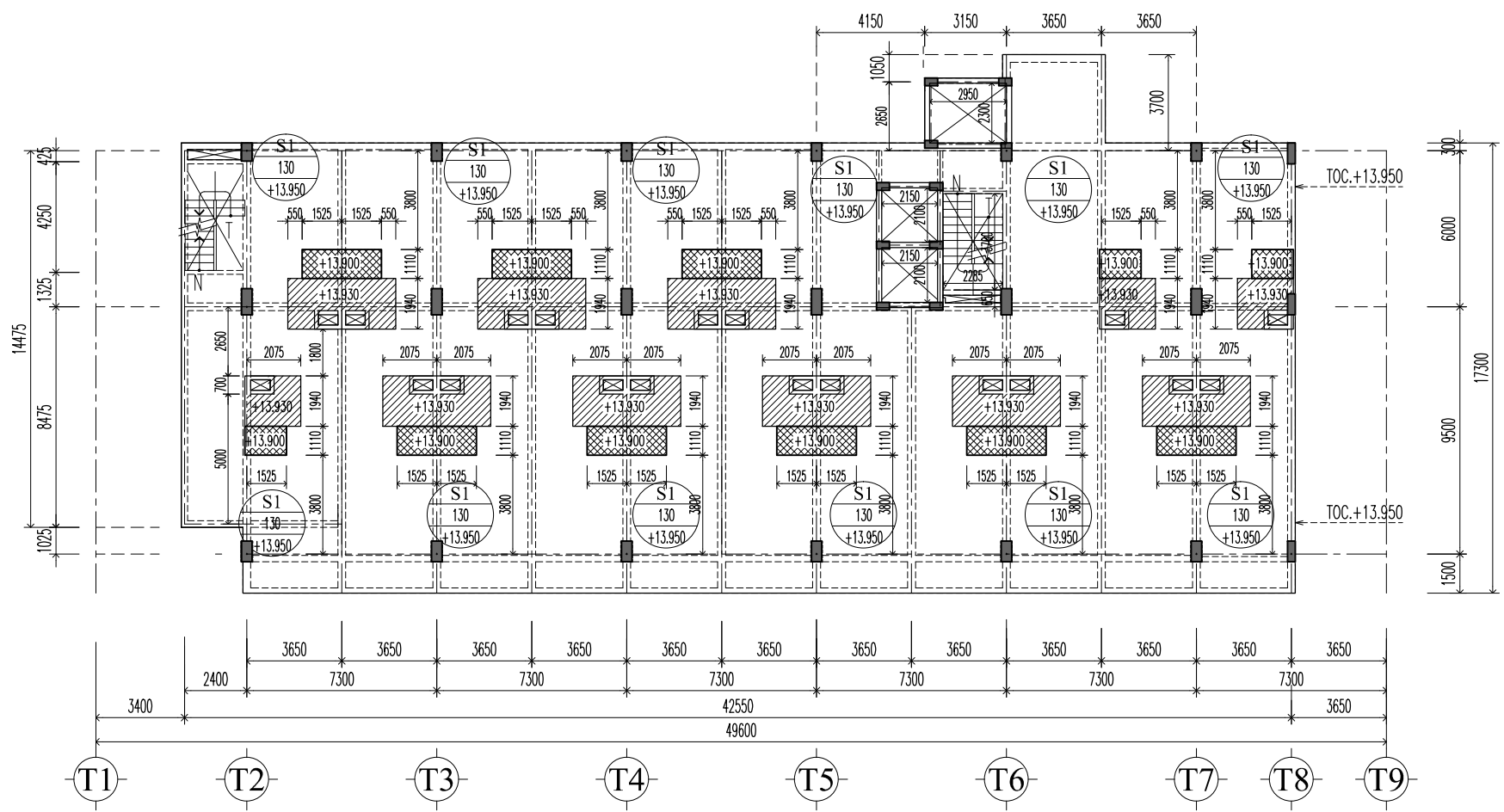

DENAH SLAB LT. - 3
SKALA 1:250

- TEBAL PLAT = 130 MM
- WIREMESH M.8 2 LAPIS

Notes :

NO	REVISION	DATE	SIGN
0		7/4/14	

Key Plan :

Proyek :
Project Hotel Arum Lombok

Pemberi Tugas :
Owner PT. Mataram Andalas Semesta

APPROVAL :
BY OWNER Ibu. Intan Fitrianti

Konsultan Arsitek :
Architect Consultant
PT. ARSITA INTERKREASI
ARCHITECTURE, INTERIOR, LANDSCAPE
JL. PULOMAS UTARA BID NO.1 PULOMAS - JAKARTA TIMUR
TELP (62-21) 4892635 47882346 47882313

Konsultan Interior :
Interior Consultant

Konsultan Struktur :
Konsultan Struktur
PT. ADINATA SURYA PRATAMA
ENGINEERING CONSULTANT
Ruko Palazzo Blok F2 NO. 5&7 Bumi Anjgrek Jl. Karangasatira, Bekasi
Telp. (021) 92757000, 081389897877
E-mail : adinatas1@gmail.com, pusapryono@yahoo.com

Konsultan M & E :
M & E Consultant
PT. EMSE
KOMPLEK TAMAN KENCANA BLOK E1 NO.20
LINGKAR LUAR CENGKARENG, JAKARTA 11730

Judul gambar :
Drawing Title **DENAH BALOK & SLAB LANTAI - 3**

Drawn By	Putut	DATE	23/03/14
Job Captain		DATE	
Project Architect		DATE	
Project Manager		DATE	
Project Director		DATE	
OWNER APPROVAL		DATE	

SCALE 1 : 250

ISSUED FOR	REVISION	DRAWING CODE/NO
CONTRACT.	0	S-01.11
DATE	7/4/14	

FILE :

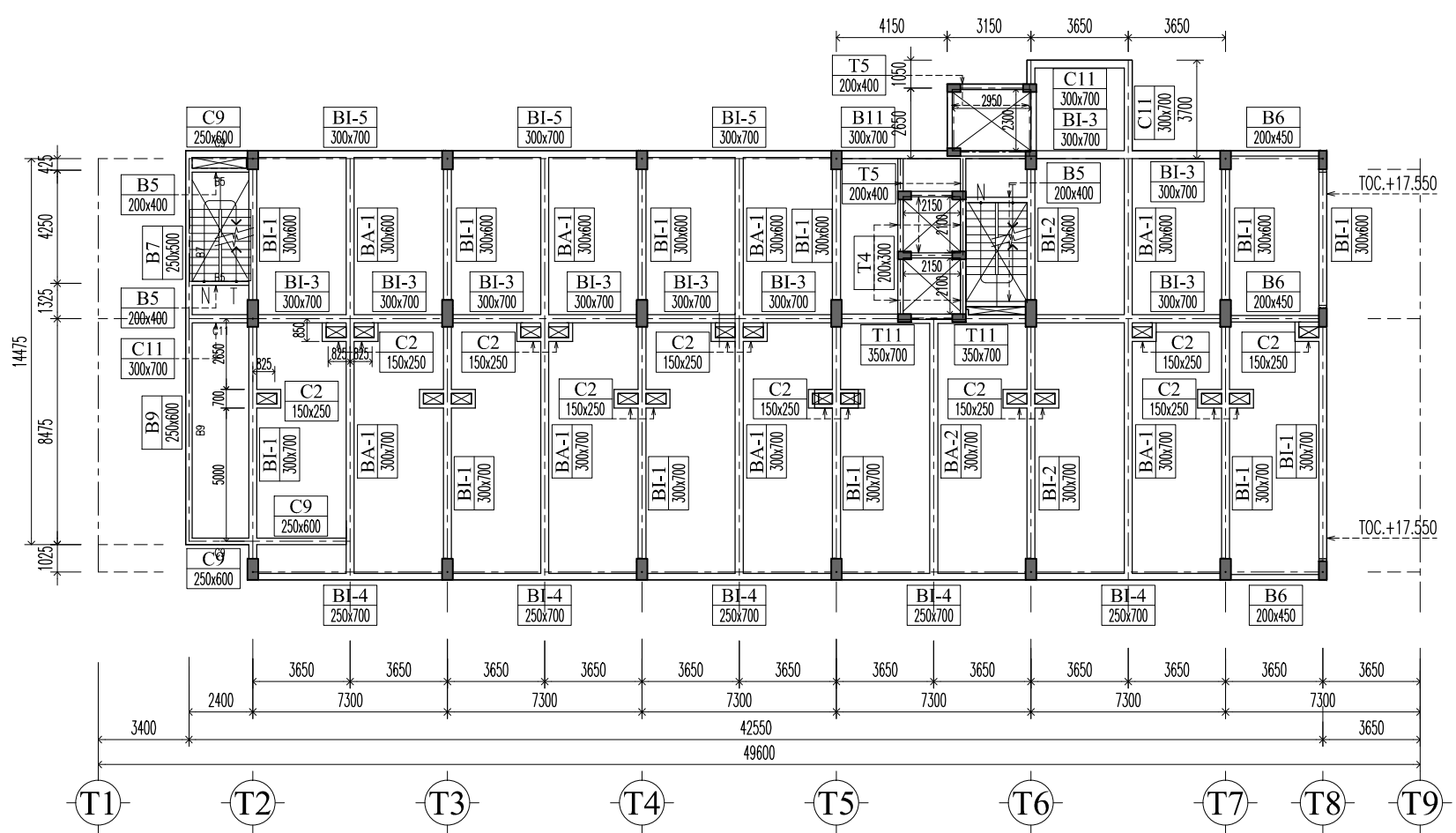

DENAH BALOK LT. - 5
SKALA 1:250

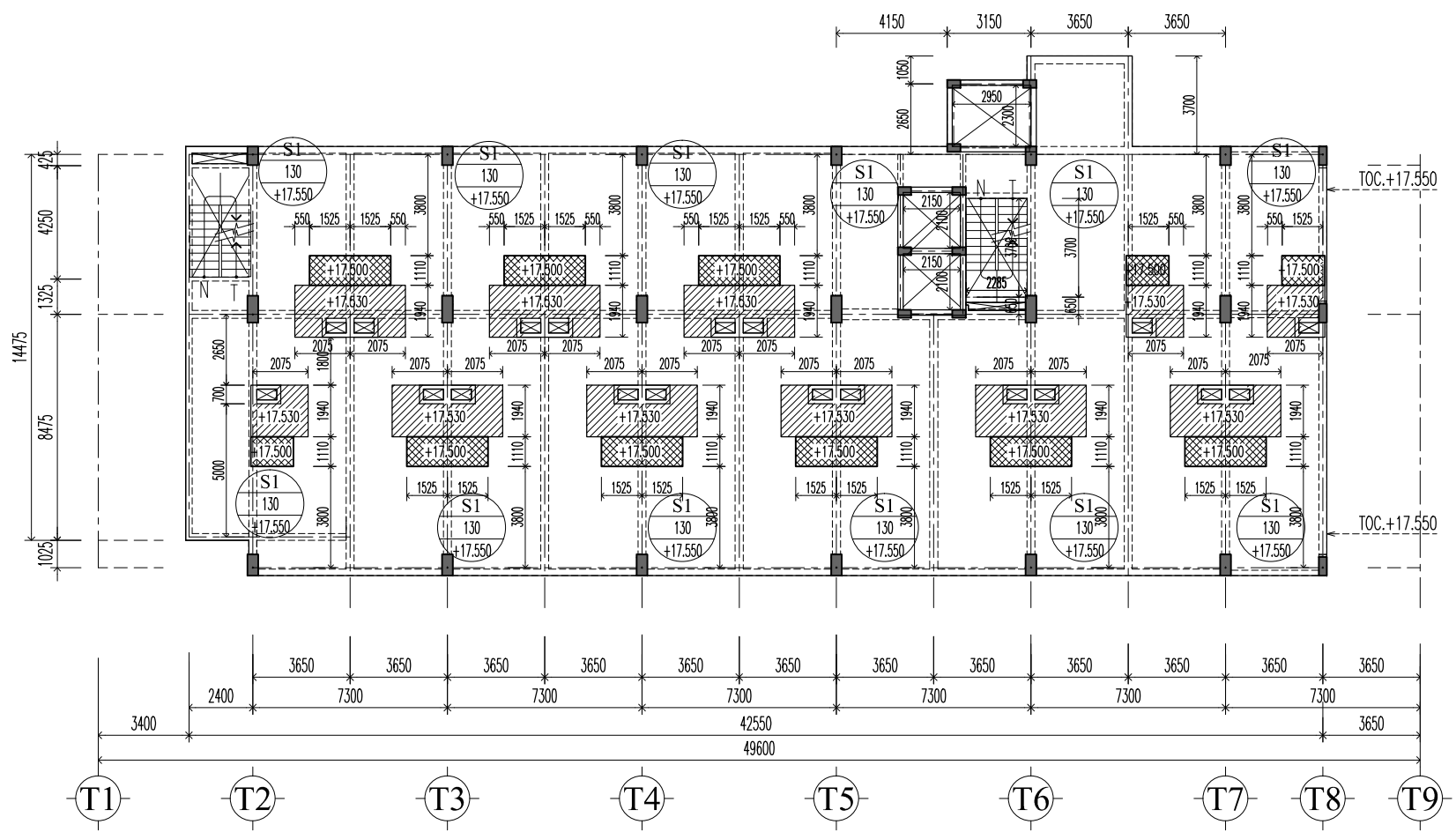

DENAH SLAB LT. - 5
SKALA 1:250

- TEBAL PLAT = 130 MM
- WIREMESH M.8 2 LAPIS

Notes :

NO	REVISION	DATE	SIGN
0		7/4/14	

Key Plan :

Proyek :
Project Hotel Arum Lombok

Pemberi Tugas :
Owner PT. Mataram Andalas Semesta

APPROVAL :
BY OWNER Ibu. Intan Fitrianti

Konsultan Arsitek :
Architect Consultant
PT. ARSITA INTERKREASI
ARCHITECTURE, INTERIOR, LANDSCAPE
JL. PULOMAS UTARA BID NO.1 PULOMAS - JAKARTA TIMUR
TELP (62-21) 4892635 47882346 47882313

Konsultan Interior :
Interior Consultant

Konsultan Struktur :
Konsultan Struktur
PT. ADINATA SURYA PRATAMA
ENGINEERING CONSULTANT
Ruko Palazzo Blok F2 NO. 5&7 Bumi Anegrek Jl. Karangasatira, Bekasi
Telp. (021) 92757000, 081389897877
E-mail : adinatas1@gmail.com, pusayyong@yahoo.com

Konsultan M & E :
M & E Consultant
PT. EMSE
KOMPLEK TAMAN KENCANA BLOK E1 NO.20
LINGKAR LUAR CENGKARENG, JAKARTA 11730

Judul gambar :
Drawing Title **DENAH BALOK & SLAB LANTAI - 5**

Drawn By	Putut	DATE	23/03/14
Job Captain		DATE	
Project Architect		DATE	
Project Manager		DATE	
Project Director		DATE	
OWNER APPROVAL		DATE	
SCALE	1 : 250		
ISSUED FOR	REVISION	DRAWING CODE/NO	
CONTRACT.	0	S-01.12	
DATE	7/4/14		
FILE :			

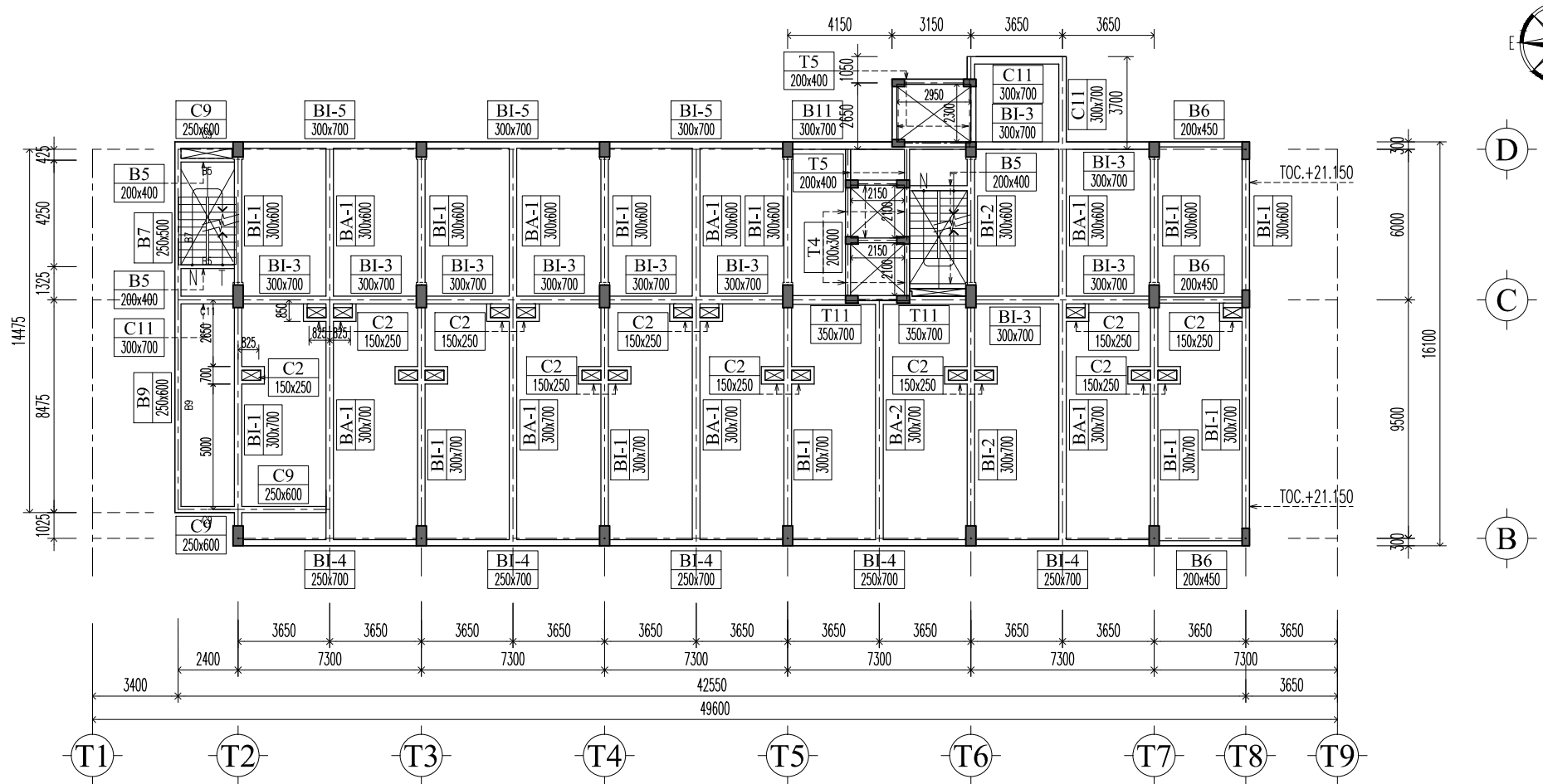
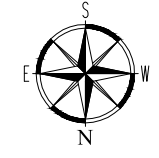

DENAH BALOK LT. - 6
SKALA 1:250

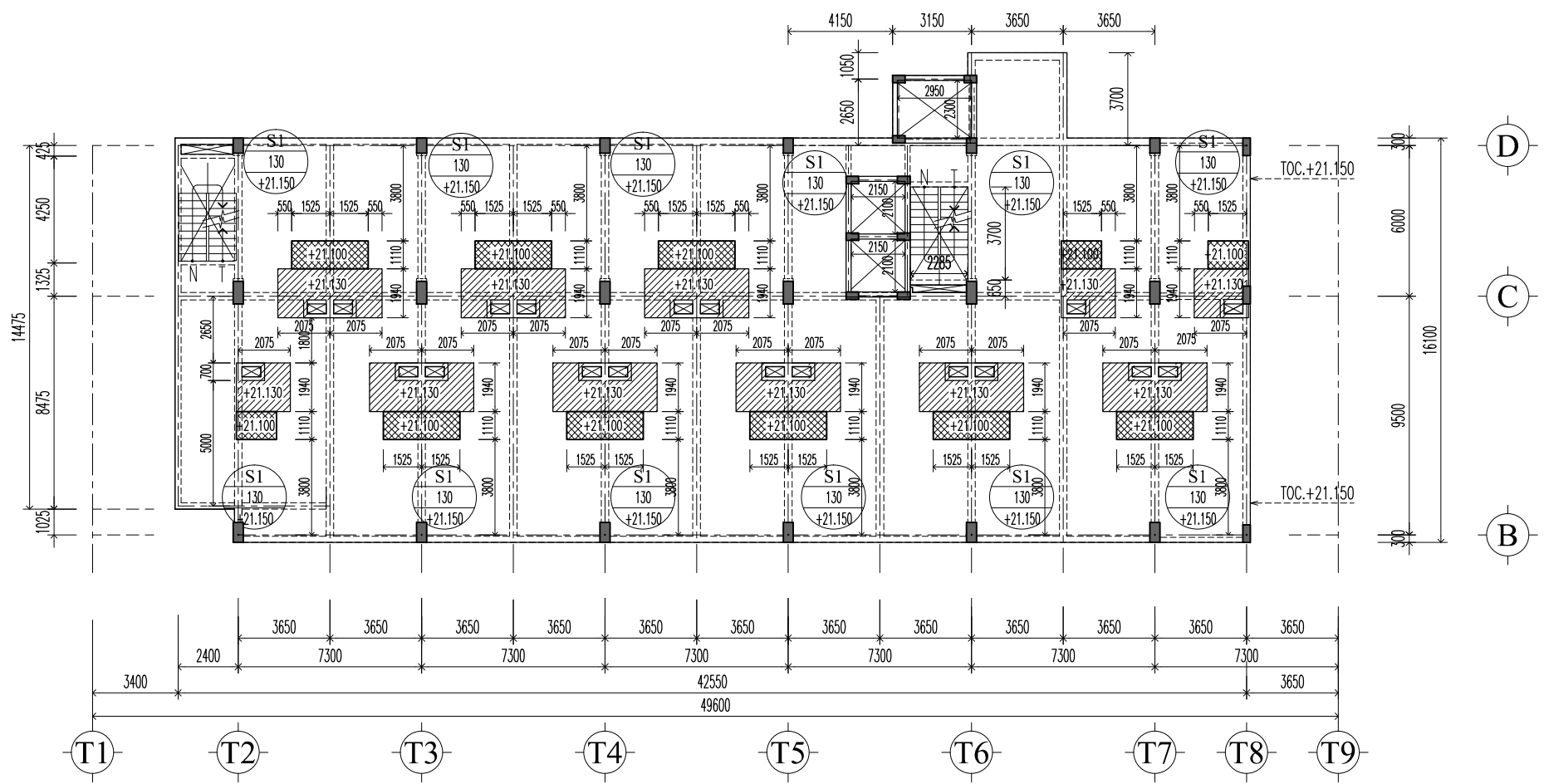

DENAH SLAB LT. - 6
SKALA 1:250

- TEBAL PLAT = 130 MM
- WIREMESH M.8 2 LAPIS

Notes :

NO	REVISION	DATE	SIGN
0		7/4/14	

Key Plan :

Proyek :
Project Hotel Arum Lombok

Pemberi Tugas :
Owner PT. Mataram Andalas Semesta

APPROVAL :
BY OWNER Ibu. Intan Fitrianti

Konsultan Arsitek :
Architect Consultant
PT. ARSITA INTERKREASI
ARCHITECTURE, INTERIOR, LANDSCAPE
JL. PULOMAS UTARA BID NO.1 PULOMAS - JAKARTA TIMUR
TELP (62-21) 4892635 47882346 47882313

Konsultan Interior :
Interior Consultant

Konsultan Struktur :
Konsultan Struktur
PT. ADINATA SURYA PRATAMA
ENGINEERING CONSULTANT
Ruko Palazzo Blok F2 NO. 5&7 Bumi Anjrek JI. Karangasatna, Bekasi
Telp. (021) 92757000, 081389897877
E-mail : adinatas1@gmail.com, pusasyono@yahoo.com

Konsultan M & E :
M & E Consultant
PT. EMSE
KOMPLEK TAMAN KENCANA BLOK E1 NO.20
LINGKAR LUAR CENGKARENG, JAKARTA 11730

Judul gambar :
Drawing Title **DENAH BALOK & SLAB LANTAI - 6**

Drawn By	Putut	DATE	18/03/14
Job Captain		DATE	
Project Architect		DATE	
Project Manager		DATE	
Project Director		DATE	
OWNER APPROVAL		DATE	

SCALE 1 : 250

ISSUED FOR	REVISION	DRAWING CODE/NO
CONTRACT.	0	S-01.13
DATE	18/03/14	

FILE :

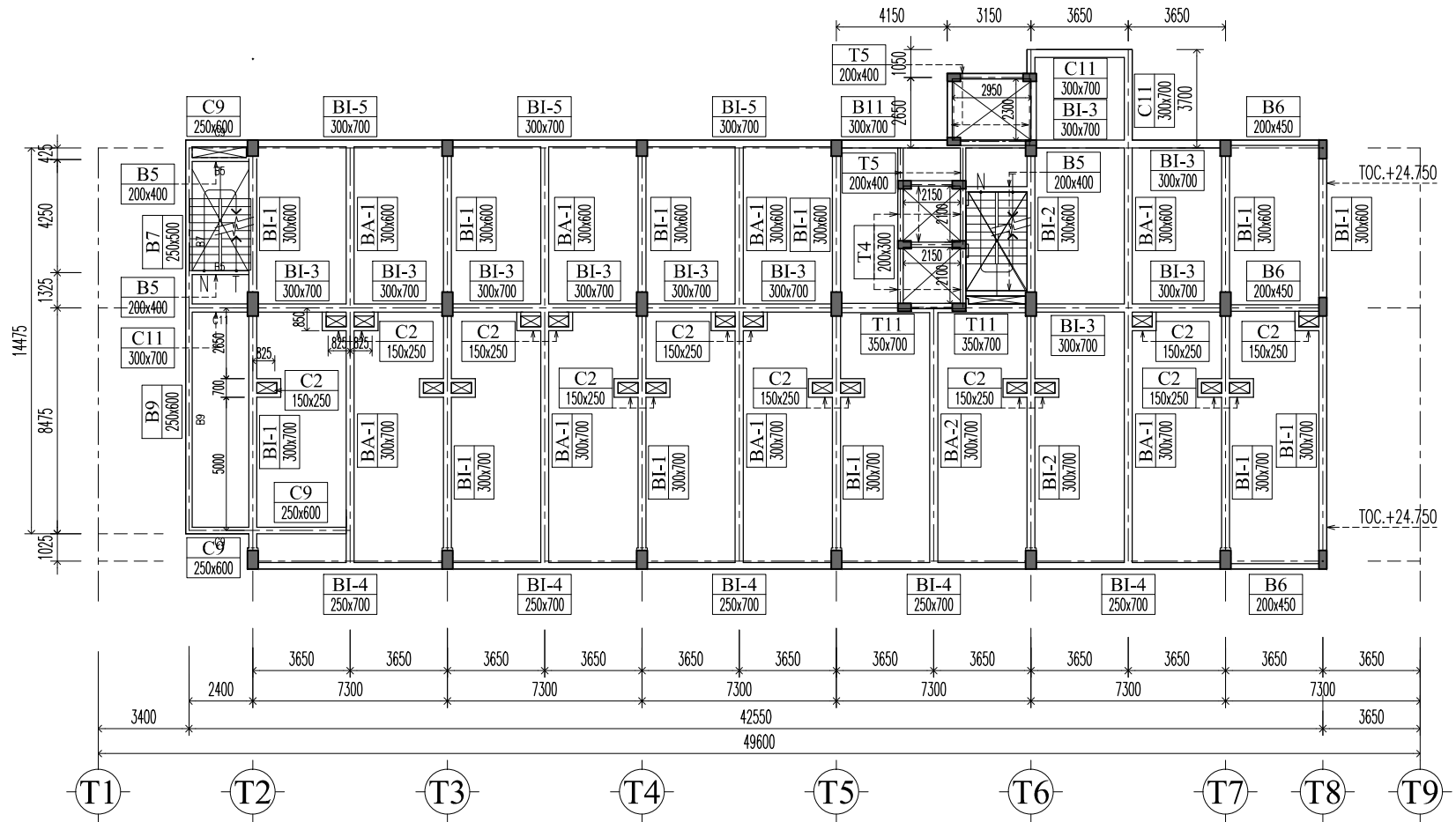
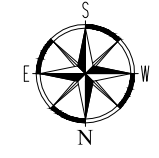

DENAH BALOK LT. - 7
SKALA 1:250

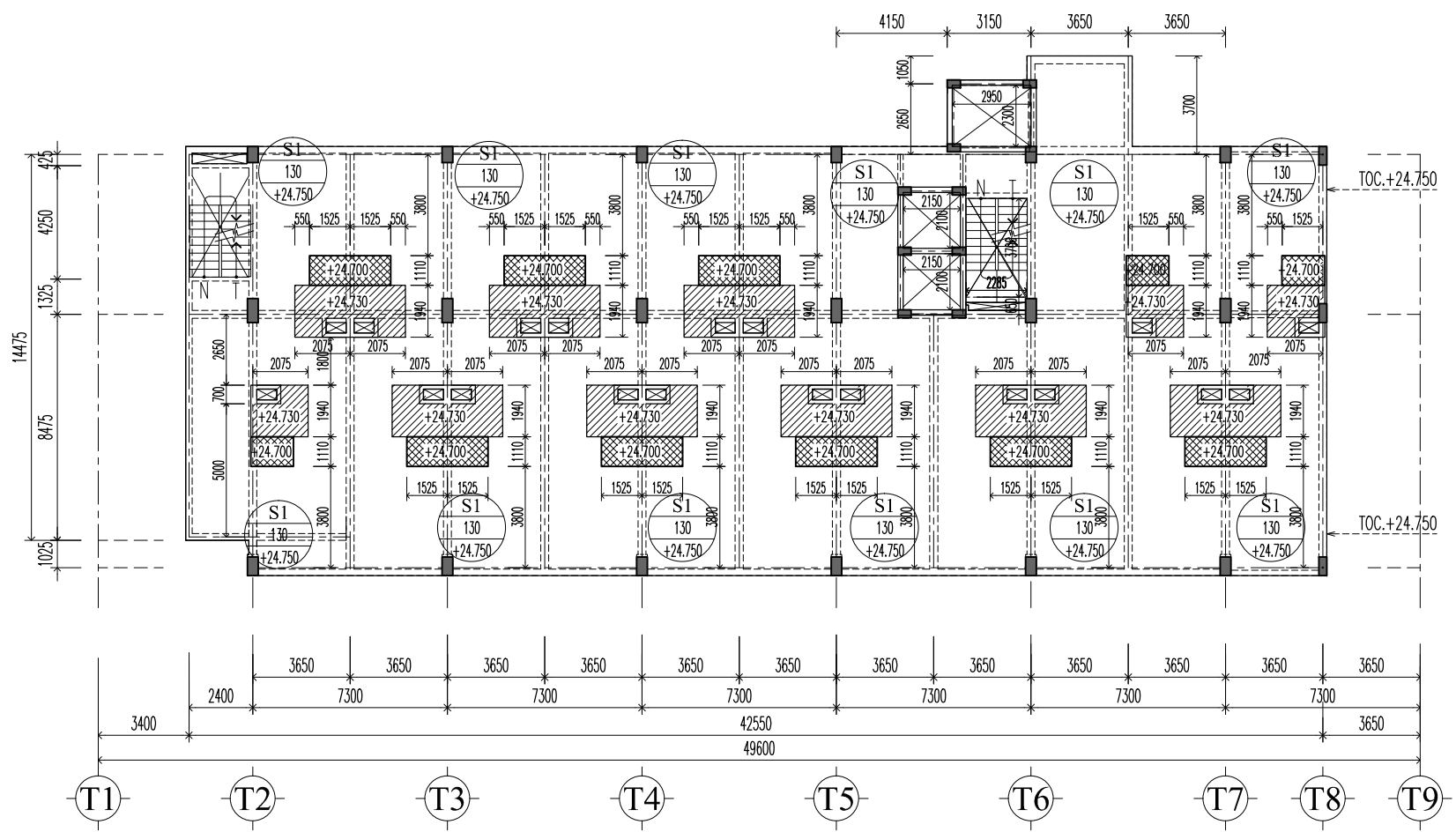

DENAH SLAB LT. - 7
SKALA 1:250

- TEBAL PLAT = 130 MM
- WIREMESH M.8 2 LAPIS

Notes :

NO	REVISION	DATE	SIGN
0		7/4/14	

Key Plan :

Proyek :
Project Hotel Arum Lombok

Pemberi Tugas :
Owner PT. Mataram Andalas Semesta

APPROVAL :
BY OWNER Ibu. Intan Fitrianti

Konsultan Arsitek :
Architect Consultant
PT. ARSITA INTERKREASI
ARCHITECTURE, INTERIOR, LANDSCAPE
ENGINEERING CONSULTANT
Jl. PULOMAS UTARA BID NO.1 PULOMAS - JAKARTA TIMUR
Telp. (021) 92757000, 081389897877
E-mail : arsitast1@gmail.com, pusaryono@yahoo.com

Konsultan Interior :
Interior Consultant

Konsultan Struktur :
Konsultan Struktur
PT. ADINATA SURYA PRATAMA
ENGINEERING CONSULTANT
Ruko Palazzo Blok F2 NO. 5&7 Bumi Anegrek Jl. Karangasatna, Bekasi
Telp. (021) 92757000, 081389897877
E-mail : adinast1@gmail.com, pusaryono@yahoo.com

Konsultan M & E :
M & E Consultant
PT. EMSE
KOMPLEK TAMAN KENCANA BLOK E1 NO.20
LINGKAR LUAR CENGKARENG, JAKARTA 11730

Judul gambar :
Drawing Title **DENAH BALOK & SLAB LANTAI - 7**

Drawn By	Putut	DATE	23/03/14
Job Captain		DATE	
Project Architect		DATE	
Project Manager		DATE	
Project Director		DATE	
OWNER APPROVAL		DATE	

SCALE 1 : 250

ISSUED FOR	REVISION	DRAWING CODE/NO
CONTRACT.	0	S-01.14
DATE	7/4/14	

FILE :

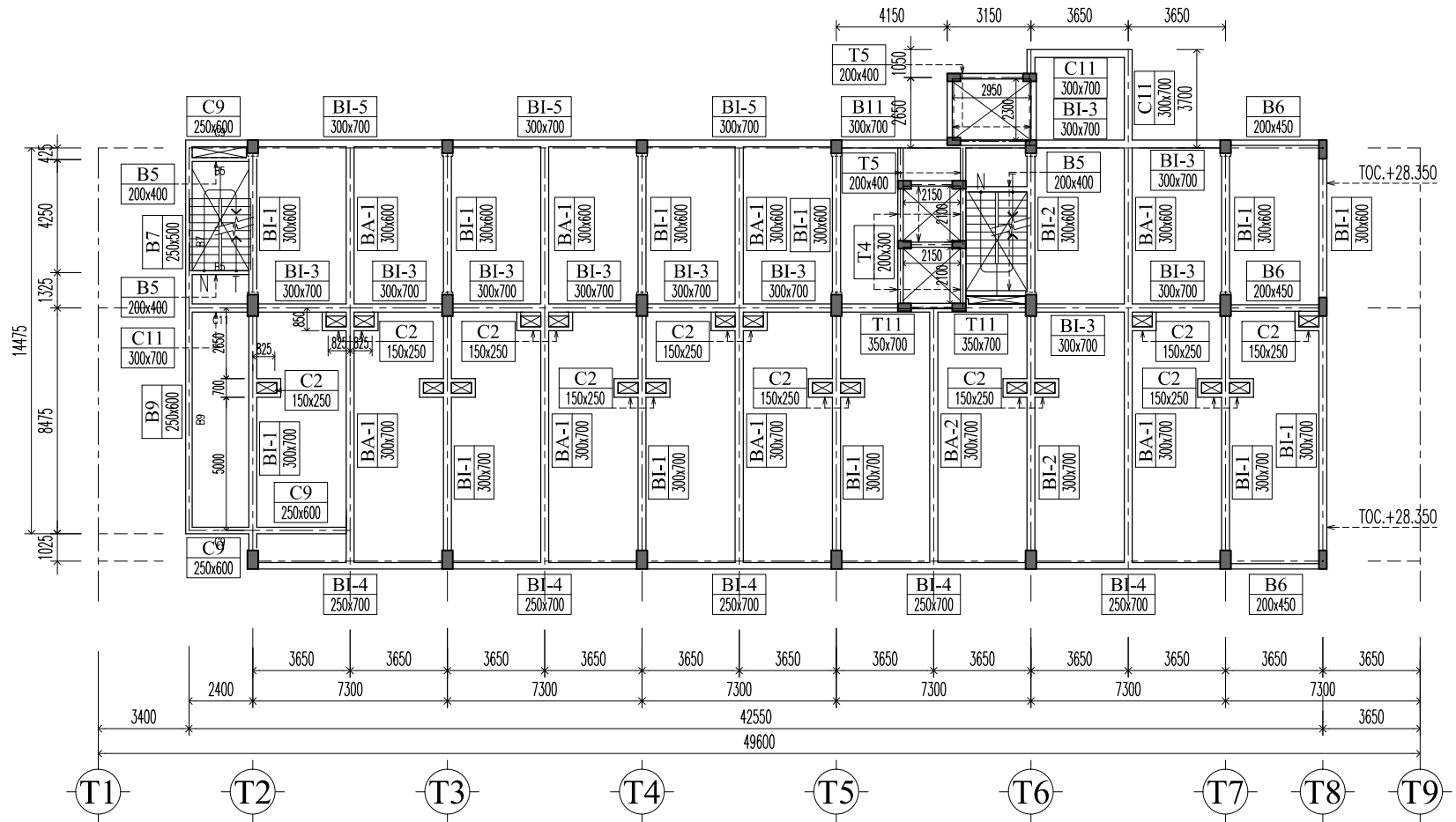

DENAH BALOK LT. - 8
SKALA 1:250

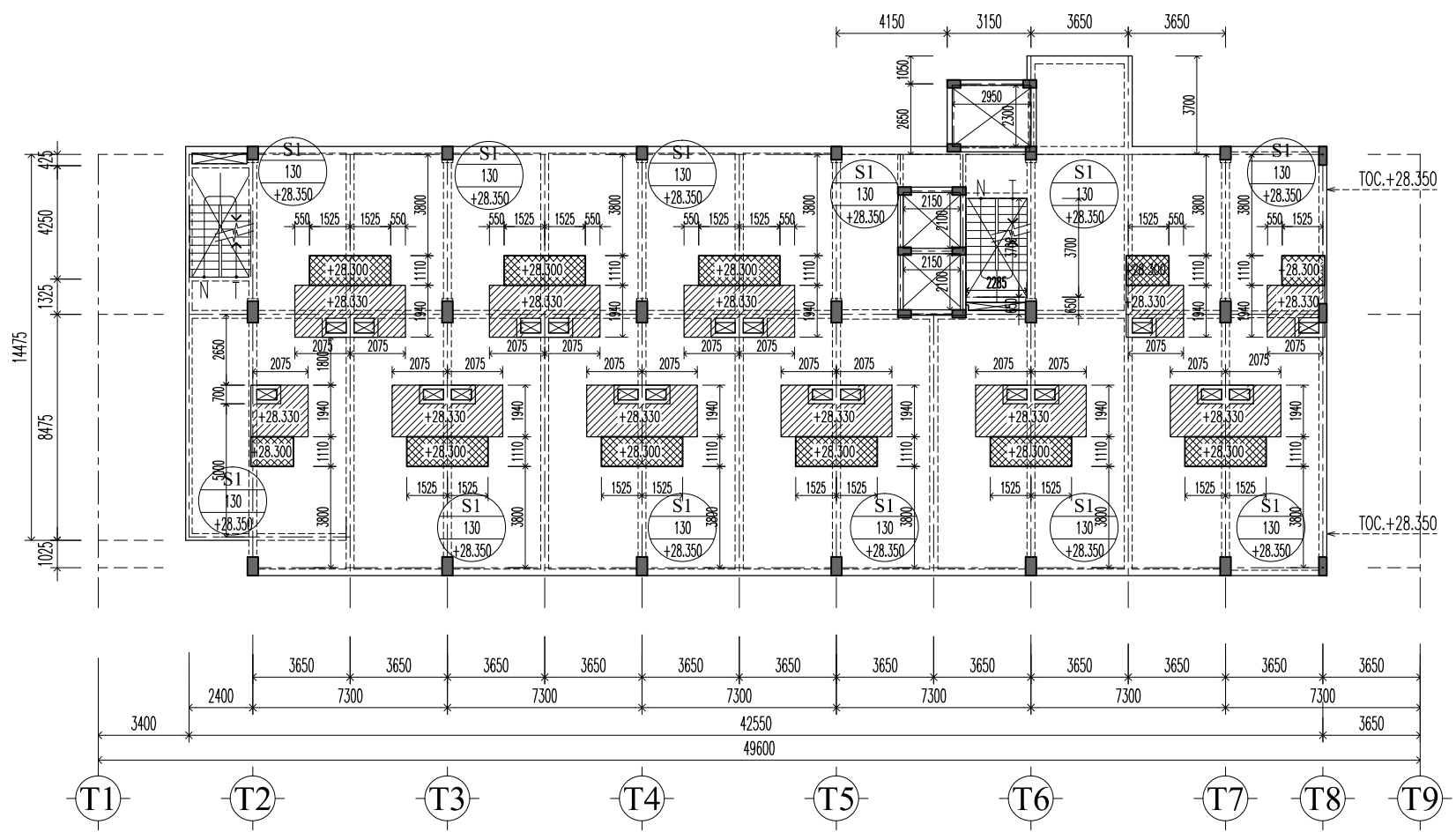

DENAH SLAB LT. - 8
SKALA 1:250

- TEBAL PLAT = 130 MM
- WIREMESH M.8 2 LAPIS

Notes :

NO	REVISION	DATE	SIGN
0		7/4/14	

Key Plan :

Proyek :
Project Hotel Arum Lombok

Pemberi Tugas :
Owner PT. Mataram Andalas Semesta

APPROVAL :
BY OWNER Ibu. Intan Fitrianti

Konsultan Arsitek :
Architect Consultant
PT. ARSITA INTERKREASI
ARCHITECTURE, INTERIOR, LANDSCAPE
JL. PULOMAS UTARA BID NO.1 PULOMAS - JAKARTA TIMUR
TELP (62-21) 4892635 47882346 47882313

Konsultan Interior :
Interior Consultant

Konsultan Struktur :
Konsultan Struktur
PT. ADINATA SURYA PRATAMA
ENGINEERING CONSULTANT
Ruko Palazzo Blok F2 NO. 5&7 Bumi Anegrek Jl. Karangasatira, Bekasi
Telp. (021) 92757000, 081389897877
E-mail : adinatas1@gmail.com, pusayyono@yahoo.com

Konsultan M & E :
M & E Consultant
PT. EMSE
KOMPLEK TAMAN KENCANA BLOK E1 NO.20
LINGKAR LUAR CENGKARENG, JAKARTA 11730

Judul gambar :
Drawing Title **DENAH BALOK & SLAB LANTAI - 8**

Drawn By	Putut	DATE	23/03/14
Job Captain		DATE	
Project Architect		DATE	
Project Manager		DATE	
Project Director		DATE	
OWNER APPROVAL		DATE	
SCALE	1 : 250		
ISSUED FOR	REVISION	DRAWING CODE/NO	
CONTRACT.	0	S-01.15	
DATE	7/4/14		
FILE :			

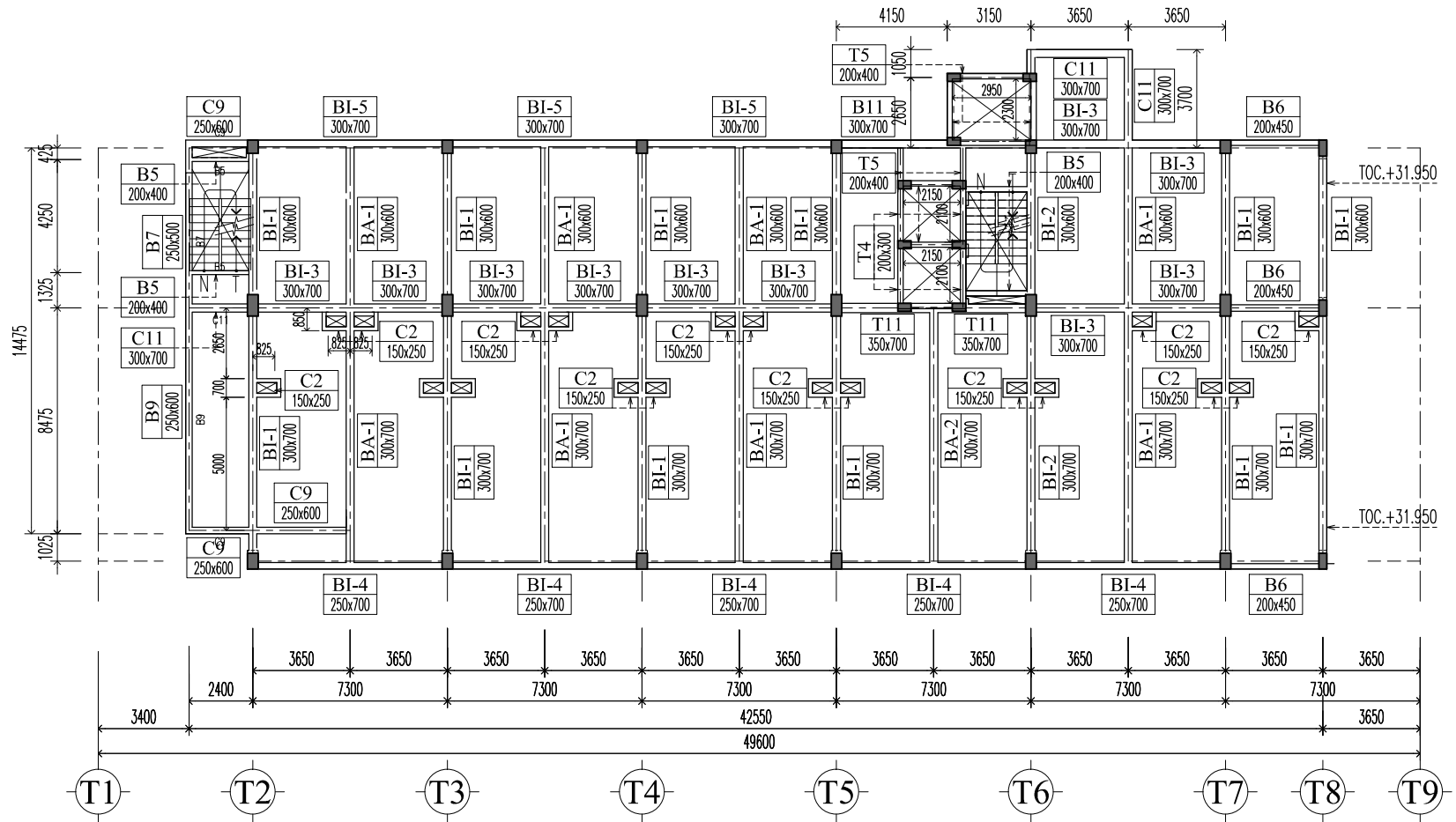
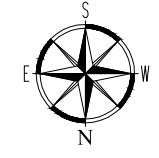

DENAH BALOK LT. - 9
SKALA 1:250

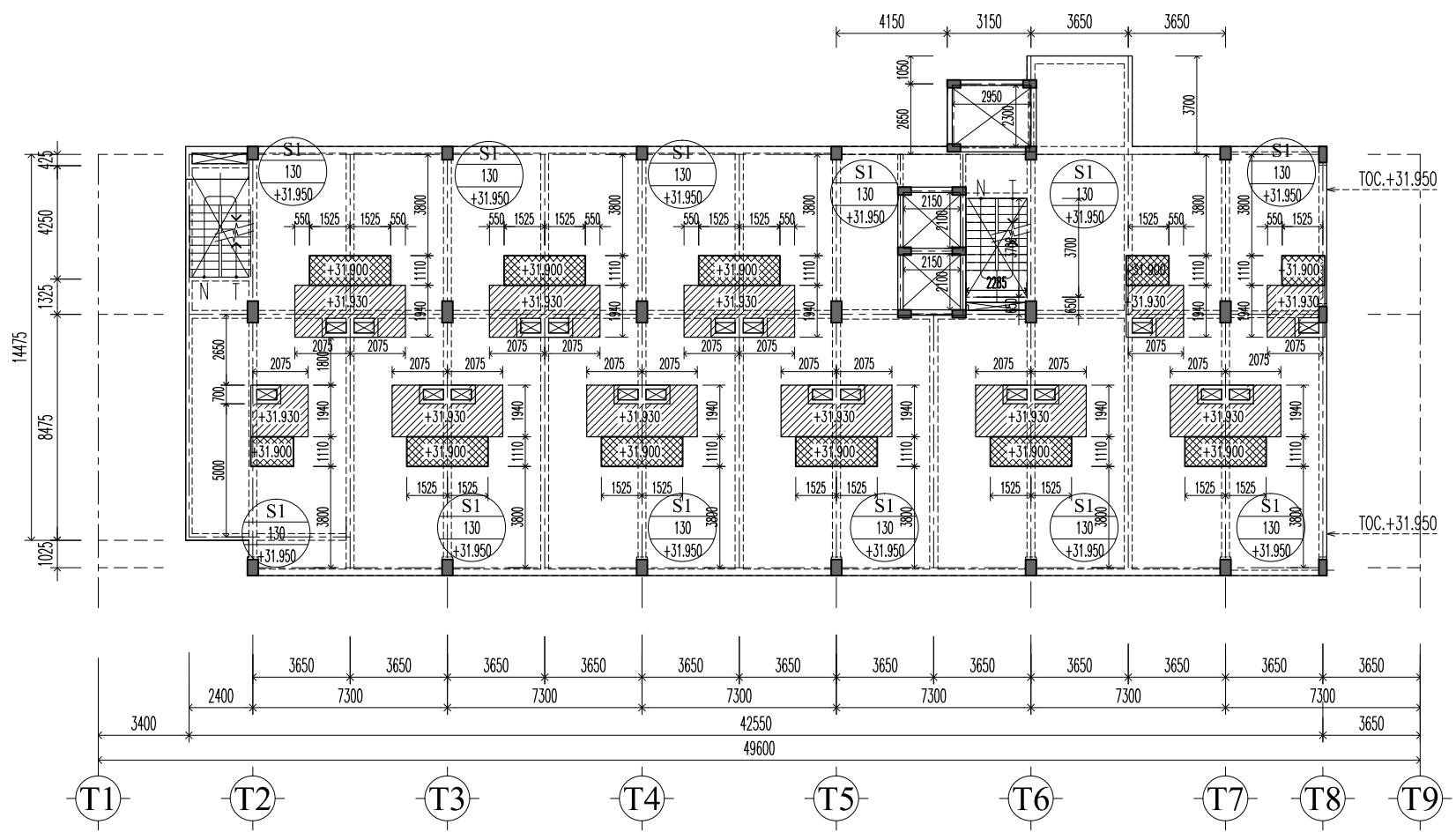

DENAH SLAB LT. - 9
SKALA 1:250

- TEBAL PLAT = 130 MM
- WIREMESH M.8 2 LAPIS

Notes :

NO	REVISION	DATE	SIGN
0		7/4/14	

Key Plan :

Proyek :
Project Hotel Arum Lombok

Pemberi Tugas :
Owner PT. Mataram Andalas Semesta

APPROVAL :
BY OWNER Ibu. Intan Fitrianti

Konsultan Arsitek :
Architect Consultant
PT. ARSITA INTERKREASI
ARCHITECTURE, INTERIOR, LANDSCAPE
JL. PULOMAS UTARA BID NO.1 PULOMAS - JAKARTA TIMUR
TELP (62-21) 4892635 47882346 47882313

Konsultan Interior :
Interior Consultant

Konsultan Struktur :
Konsultan Struktur
PT. ADINATA SURYA PRATAMA
ENGINEERING CONSULTANT
Ruko Palazzo Blok F2 NO. 5&7 Bumi Anegrek Jl. Karangasatira, Bekasi
Telp. (021) 92757000, 081389897877
E-mail : adinatas1@gmail.com, pusayyong@yahoo.com

Konsultan M & E :
M & E Consultant
PT. EMSE
KOMPLEK TAMAN KENCANA BLOK E1 NO.20
LINGKAR LUAR CENGKARENG, JAKARTA 11730

Judul gambar :
Drawing Title **DENAH BALOK & SLAB LANTAI - 9**

Drawn By	Putut	DATE	23/03/14
Job Captain		DATE	
Project Architect		DATE	
Project Manager		DATE	
Project Director		DATE	
OWNER APPROVAL		DATE	
SCALE	1 : 250		
ISSUED FOR	REVISION	DRAWING CODE/NO	
CONTRACT.	0	S-01.16	
DATE	18/03/14		

FILE :

DENAH BALOK LT. - 10
SKALA 1:250

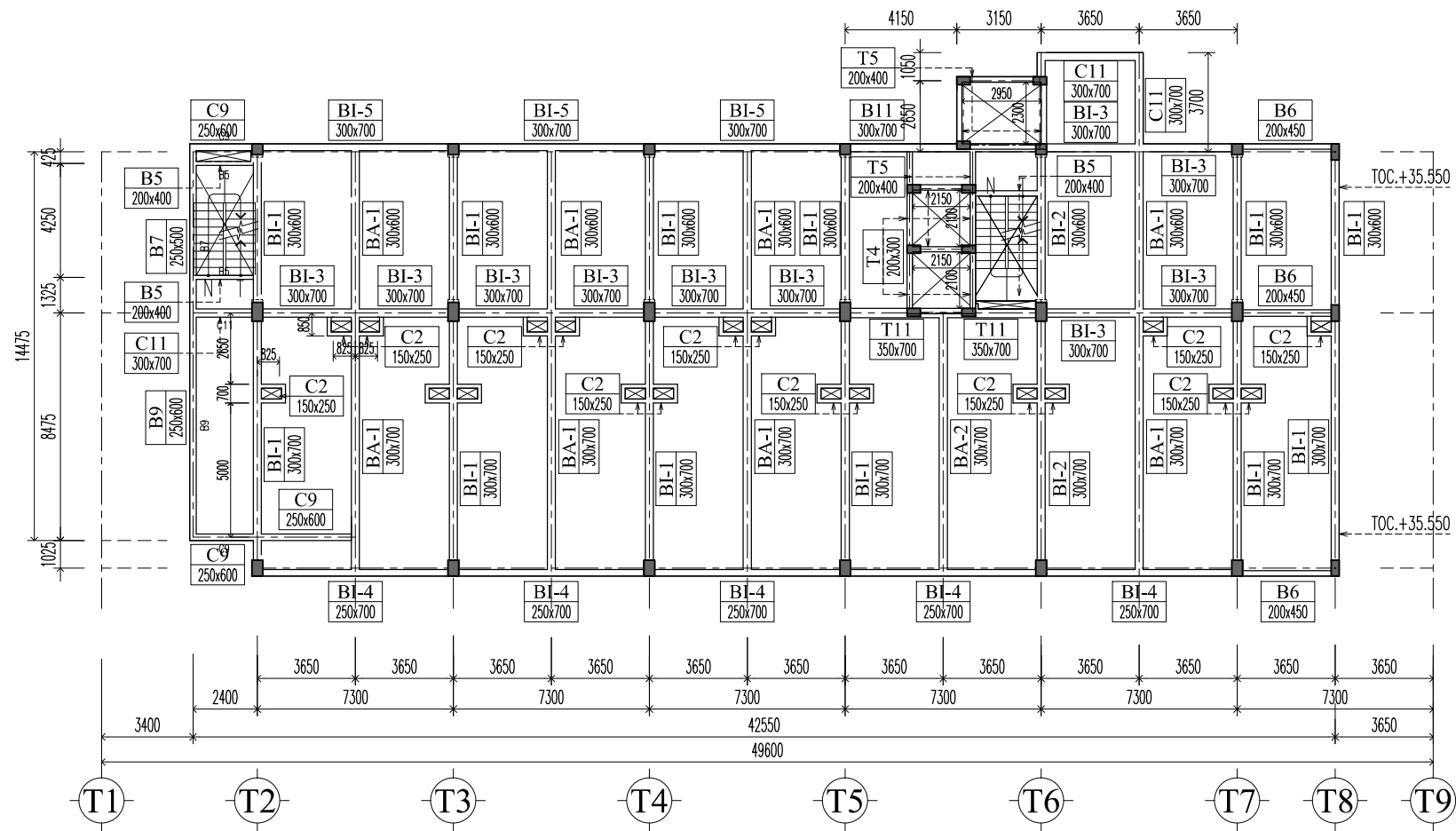

DENAH BALOK LT. - 10
SKALA 1:250

- TEBAL PLAT = 130 MM
- WIREMESH M.8 2 LAPIS

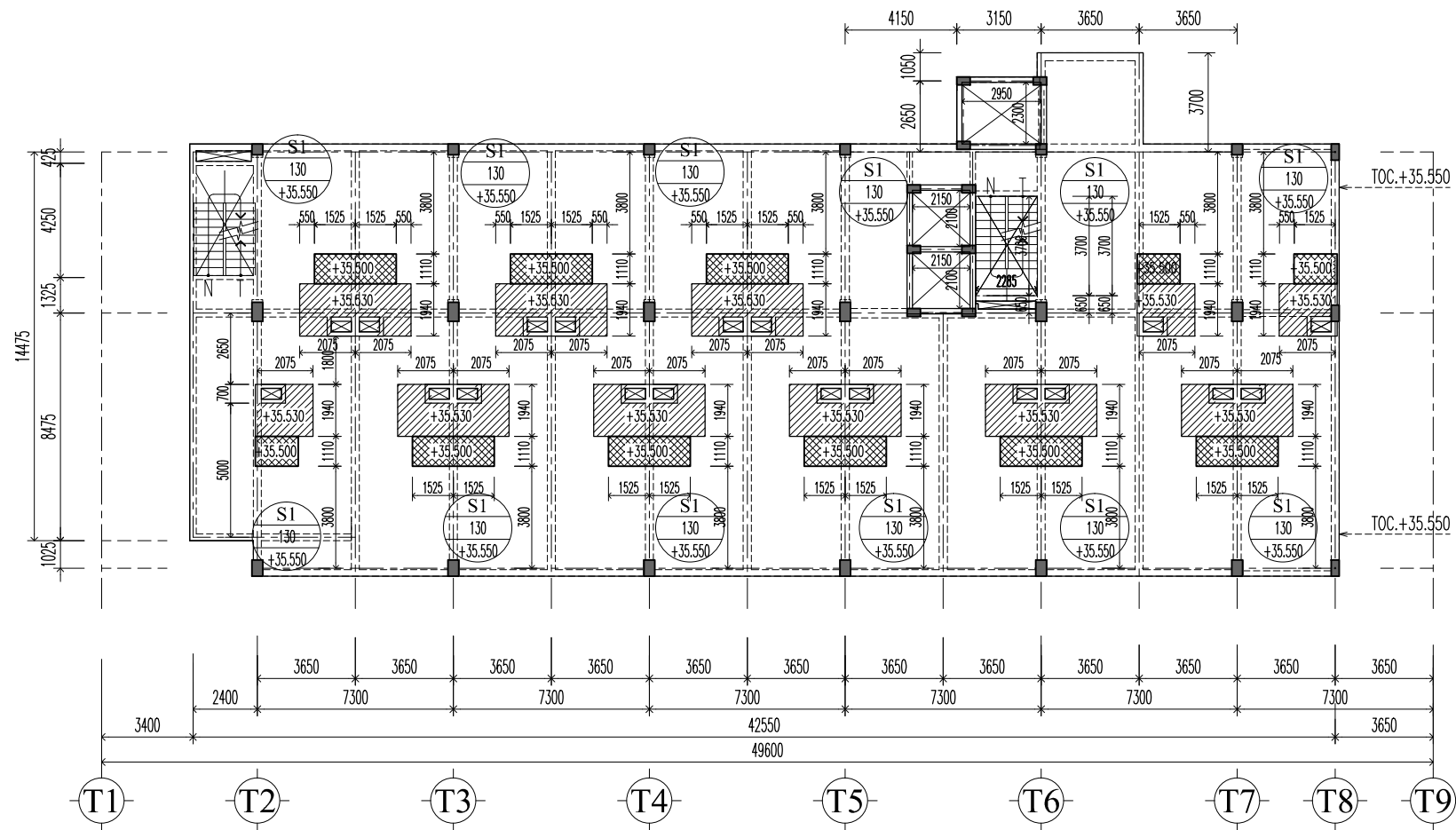

Notes :

NO	REVISION	DATE	SIGN
0		7/4/14	

Key Plan :

Proyek :
Project

Hotel Arum Lombok

Pemberi Tugas :
Owner

PT. Mataram Andalas Semesta

APPROVAL :
BY OWNER

Ibu. Intan Fitrianti

Konsultan Arsitek :
Architect Consultant

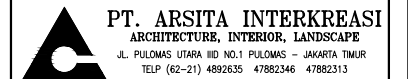

Konsultan Interior :
Interior Consultant

Konsultan Struktur :
Konsultan Struktur



Konsultan M & E :
M & E Consultant



Judul gambar :
Drawing Title

DENAH BALOK & SLAB LANTAI - 10

Drawn By	Putut	DATE	23/03/14
Job Captain		DATE	
Project Architect		DATE	
Project Manager		DATE	
Project Director		DATE	
OWNER APPROVAL		DATE	
SCALE	1 : 250		

ISSUED FOR	REVISION	DRAWING CODE/NO
CONTRACT.	0	S-01.17

DATE	7/4/14		
------	--------	--	--

FILE :

DENAH BALOK LT. - 11
SKALA 1:250

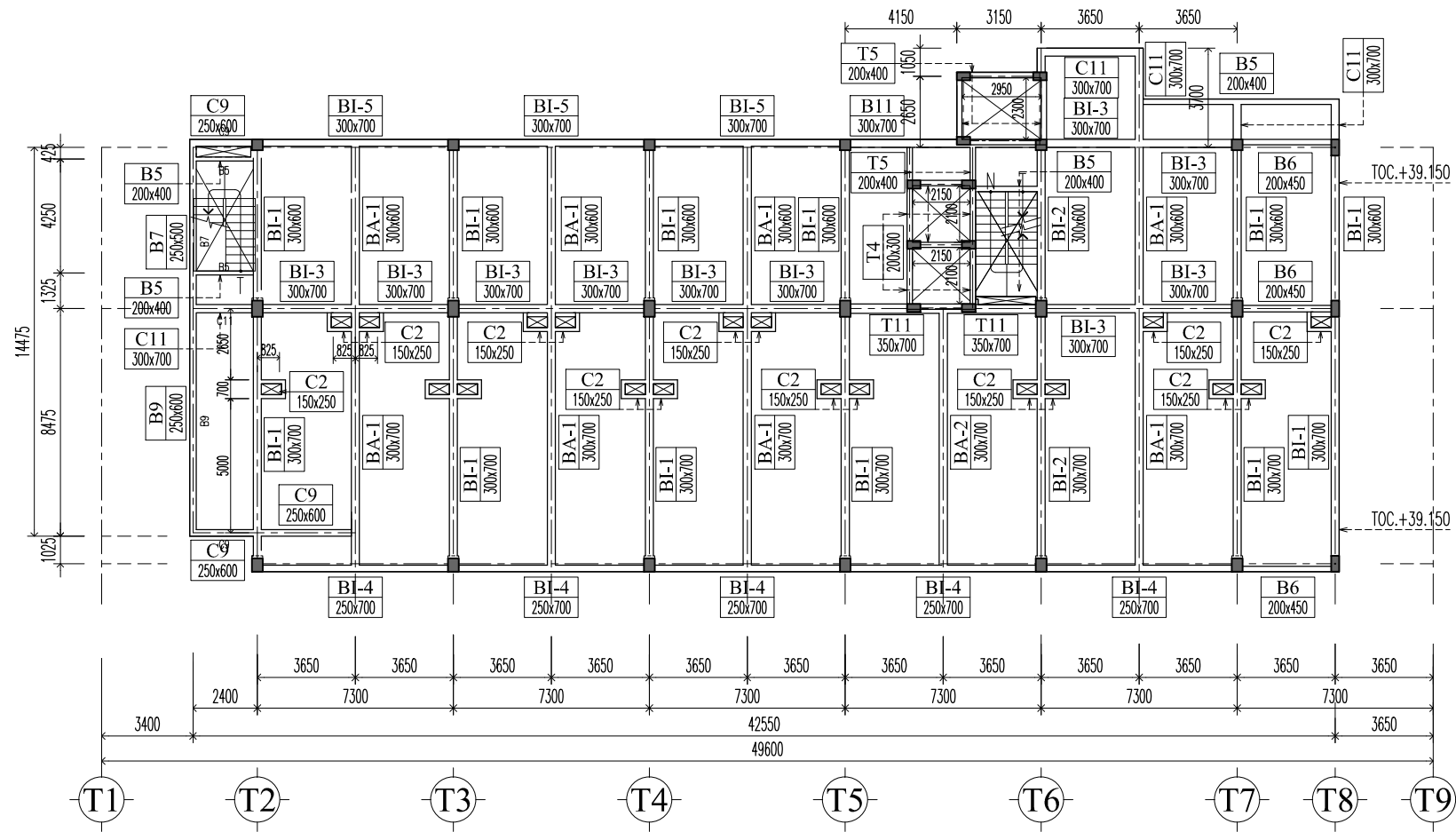

DENAH SLAB LT. - 11
SKALA 1:250

- TEBAL PLAT = 130 MM
- WIREMESH M.8 2 LAPIS

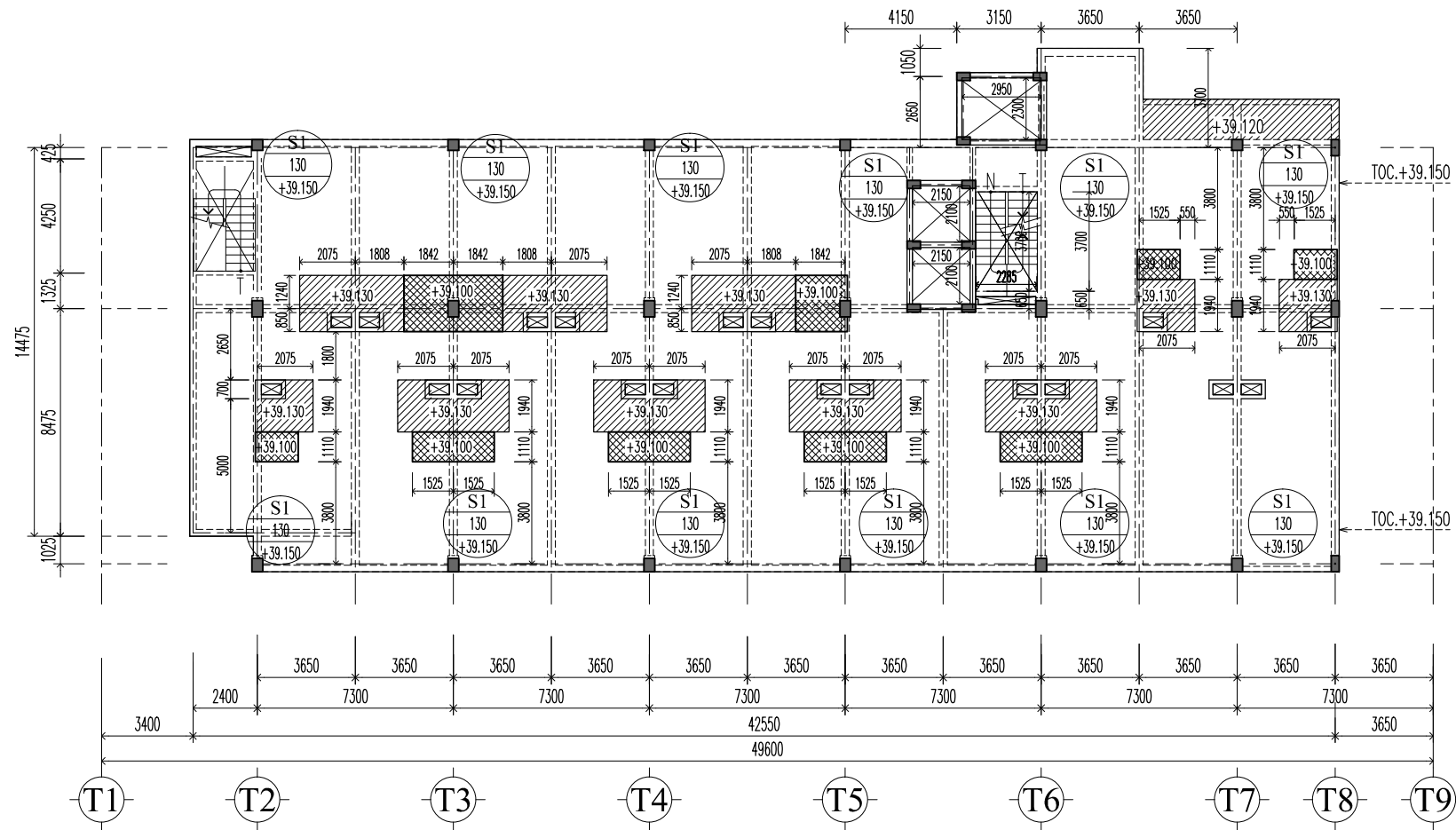

Notes :

NO	REVISION	DATE	SIGN
0		7/4/14	

Key Plan :

Proyek :
Project

Hotel Arum Lombok

Pemberi Tugas :
Owner

PT. Mataram Andalas Semesta

APPROVAL :
BY OWNER

Ibu. Intan Fitrianti

Konsultan Arsitek :
Architect Consultant



Konsultan Interior :
Interior Consultant

Konsultan Struktur :
Konsultan Struktur



Konsultan M & E :
M & E Consultant



Judul gambar :
Drawing Title

DENAH BALOK & SLAB
LANTAI - 11

Drawn By	Putut	DATE	23/03/14
Job Captain		DATE	
Project Architect		DATE	
Project Manager		DATE	
Project Director		DATE	
OWNER APPROVAL		DATE	
SCALE	1 : 250		

ISSUED FOR

CONTRACT.	REVISION	DRAWING CODE/NO
DATE	0	S-01.18
7/4/14		

FILE :

DENAH BALOK LT. ATAP

SKALA 1:250

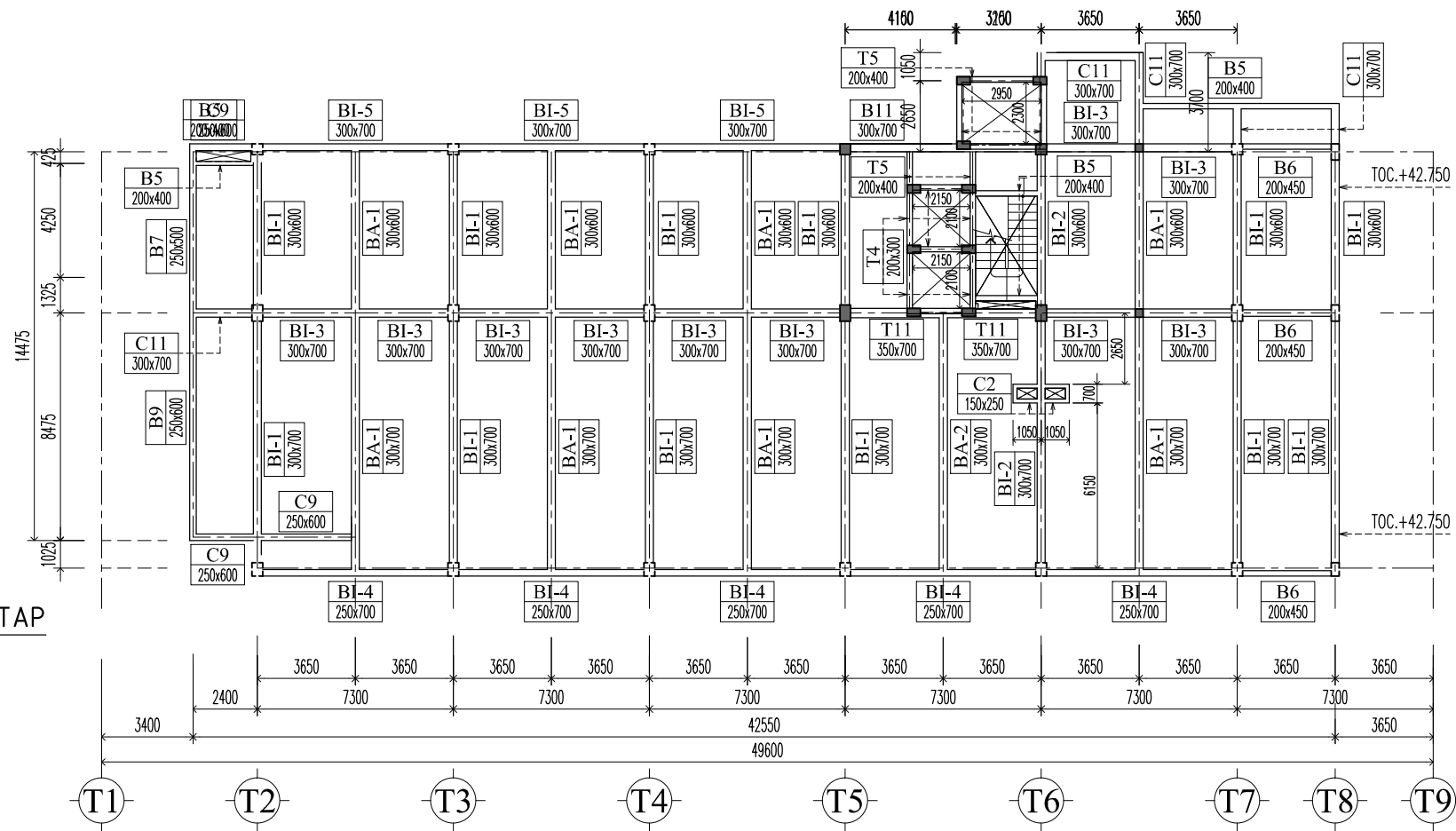

DENAHSLAB LT. ATAP

SKALA 1:250

- TEBAL PLAT = 130 MM
- WIREMESH M.8 2 LAPIS

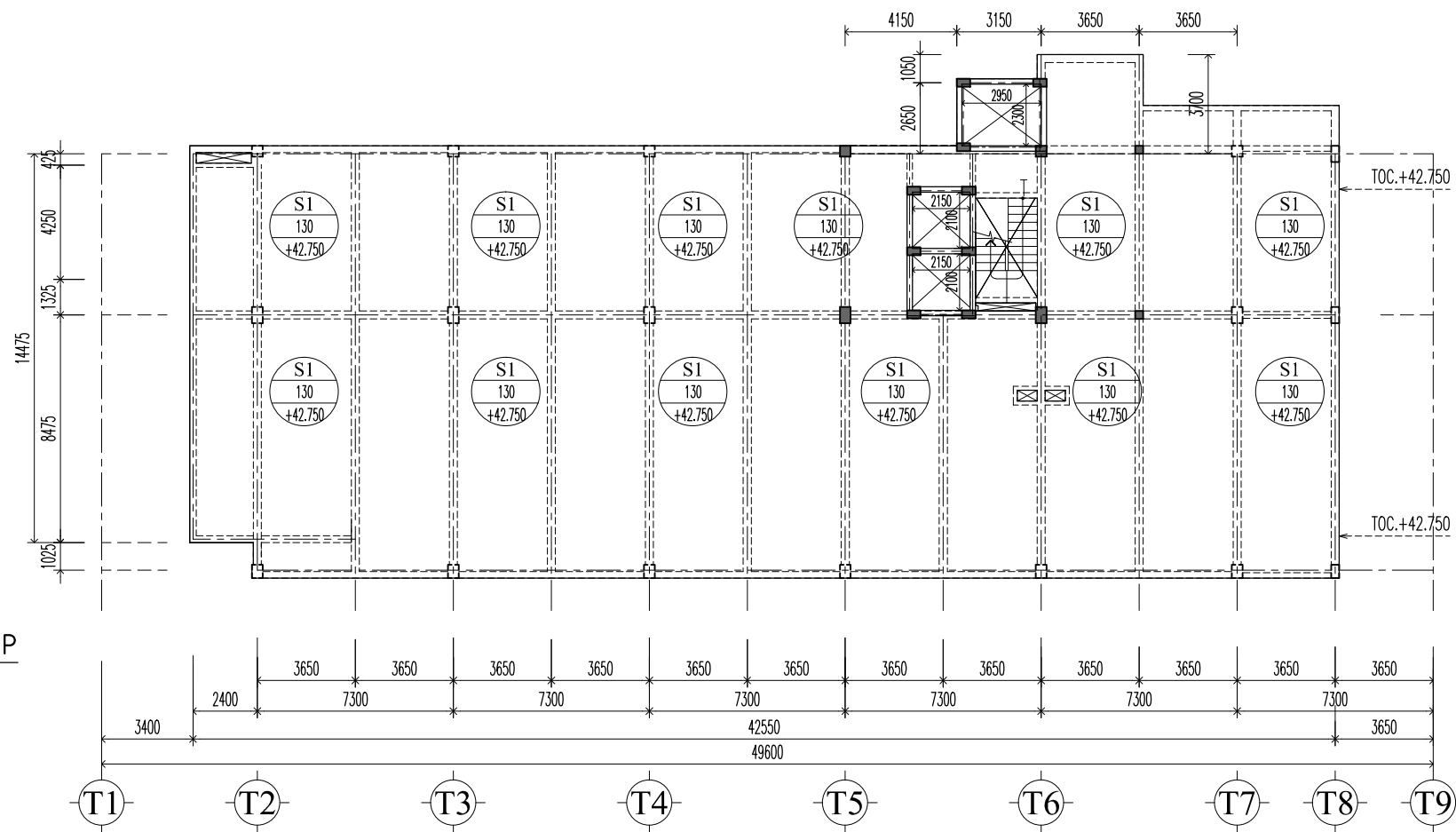

Notes :

NO	REVISION	DATE	SIGN

Key Plan :

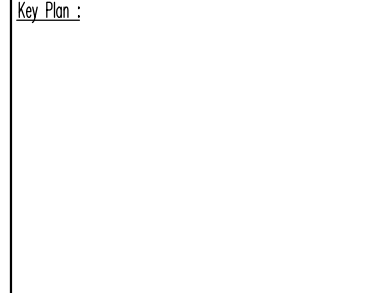

Proyek :
Project **Hotel Arum Lombok**

Pemberi Tugas :
Owner **PT. Mataram Andalas Semesta**

APPROVAL :
BY OWNER **Ibu. Intan Fitrianti**

Konsultan Arsitek :
Architect Consultant
PT. ARSITA INTERKREASI
ARCHITECTURE, INTERIOR, LANDSCAPE
JL. PULOMAS UTARA BID NO.1 PULOMAS - JAKARTA TIMUR
TELP (62-21) 4892635 47882346 47882313

Konsultan Interior :
Interior Consultant

Konsultan Struktur :
Konsultan Struktur
PT. ADINATA SURYA PRATAMA
ENGINEERING CONSULTANT
Ruko Palazzo Blok F2 NO. 5&7 Bumi Angrek Jl. Karangasatira, Bekasi
Telp. (021) 92757000, 081388997877
E-mail : adinatas1@gmail.com, pusapryono@yahoo.com

Konsultan M & E :
M & E Consultant
PT. EMSE
KOMPLEK TAMAN KENCANA BLOK E1 NO.20
LINGKAR LUAR CENGKARENG, JAKARTA 11730

Judul gambar :
Drawing Title
DENAH BALOK & SLAB LANTAI ATAP

Drawn By	Putut	DATE	23/03/14
Job Captain		DATE	
Project Architect		DATE	
Project Manager		DATE	
Project Director		DATE	
OWNER APPROVAL		DATE	
SCALE	1 : 250		

ISSUED FOR	REVISION	DRAWING CODE/NO
CONTRACT.	0	S-01.19
DATE	7/4/14	
FILE :		

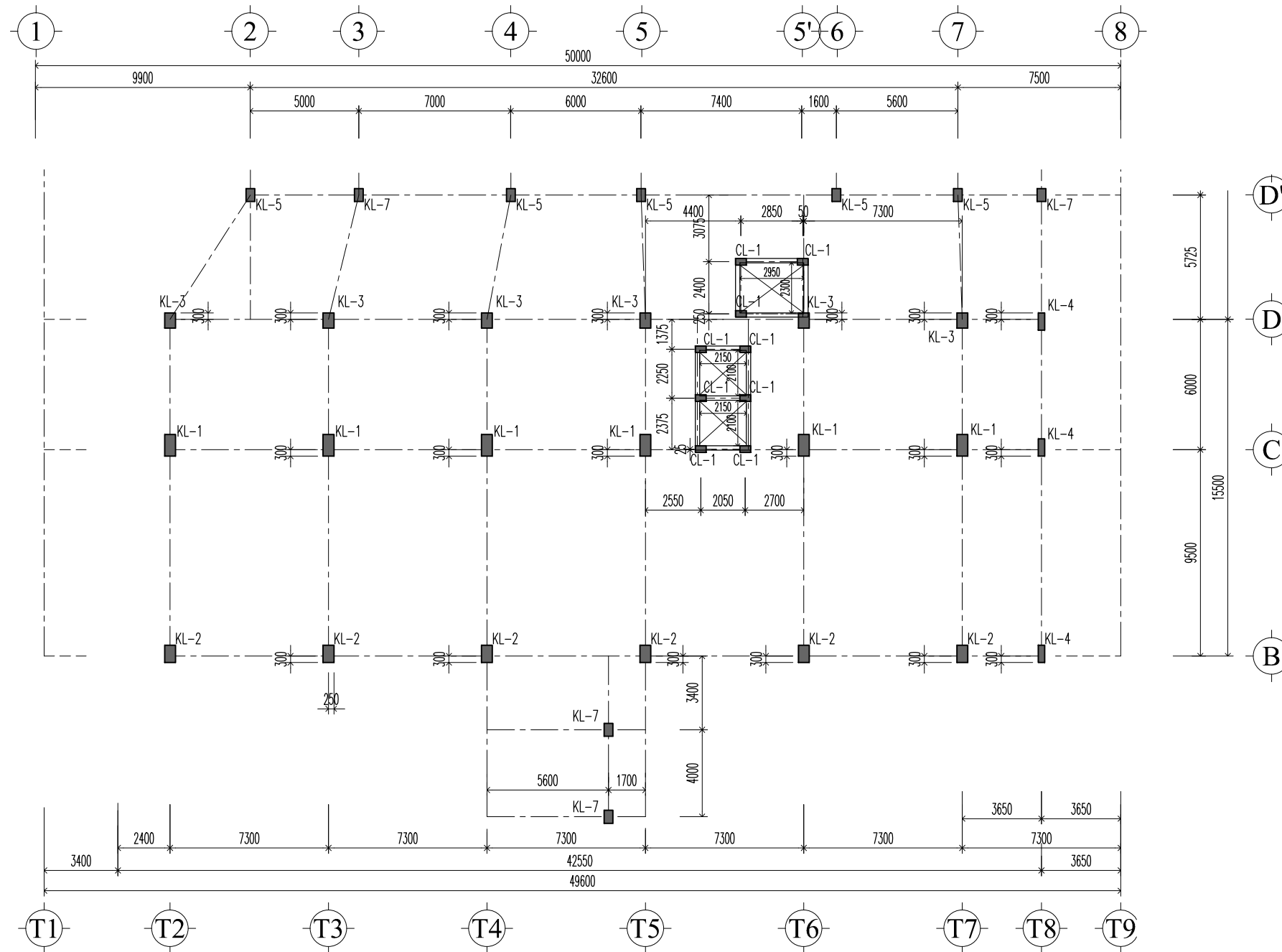

DENAH KOLOM
SKALA 1:250

Notes :

0	Issued For Contructions	7/4/14
NO	REVISION	DATE SIGN

Key Plan :

Proyek :
Project
Hotel Arum Lombok

Pemberi Tugas :
Owner
PT. Mataram Andalas Semesta

APPROVAL :
BY OWNER
Ibu. Intan Fitrianti

Konsultan Arsitek :
Architect Consultant
PT. ARSITA INTERKREASI
ARCHITECTURE, INTERIOR, LANDSCAPE
Jl. PULOMAS UTARA BID NO.1 PULOMAS - JAKARTA TIMUR
TELP (62-21) 4892635 47882346 47882313

Konsultan Interior :
Interior Consultant

Konsultan Struktur :
Konsultan Struktur
PT. ADINATA SURYA PRATAMA
ENGINEERING CONSULTANT
Ruko Palazzo Blok F2 NO. 5A7 Bumi Anggrek Jl. Karangasari, Bekasi
Telp : (021) 82757800, 08133997677
E-mail : adinad1@gmail.com, puspyono@yahoo.com

Konsultan M & E :
M & E Consultant
PT. EMSE
KOMPLEK TAMAN KENCANA BLOK E1 NO.20
LINGKAR LUAR CENGKARENG, JAKARTA 11730

Judul gambar :
Drawing Title
DENAH KOLOM
(AREA HOTEL)

Drawn By	Putut	DATE	18/03/14
Job Captain		DATE	
Project Architect		DATE	
Project Manager		DATE	
Project Director		DATE	
OWNER APPROVAL		DATE	

SCALE 1 : 250

ISSUED FOR	REVISION	DRAWING CODE/NO
CONTRACT.	0	S-01.2A
DATE	18/03/14	

FILE :

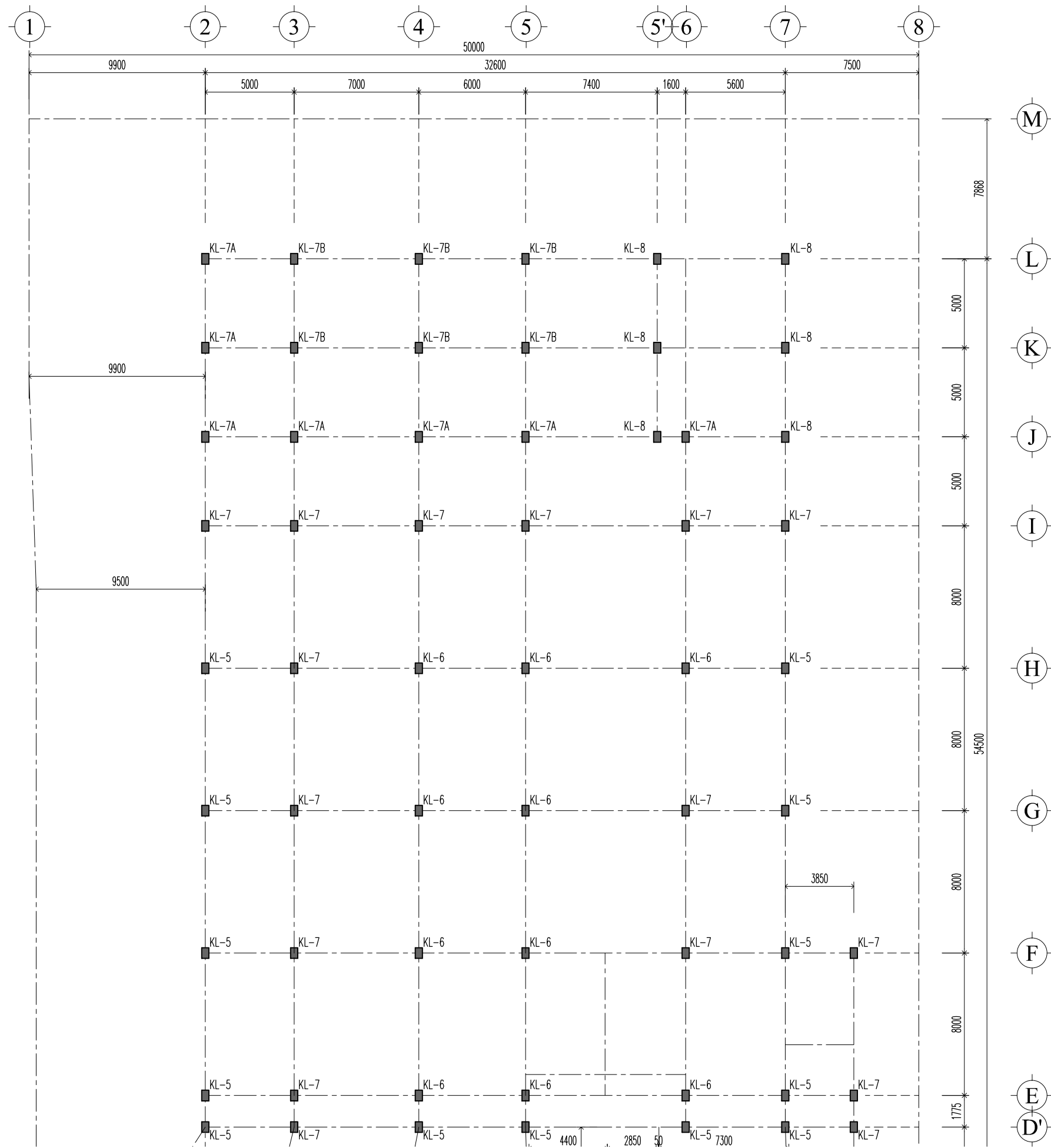

DENAH KOLOM
SKALA 1:250

Notes :

0	Issued For Contructions	7/4/14
NO	REVISION	DATE SIGN

Key Plan :

Proyek :
Project
Hotel Arum Lombok

Pemberi Tugas :
Owner
PT. Mataram Andalas Semesta

APPROVAL :
BY OWNER
Ibu. Intan Fitrianti

Konsultan Arsitek :
Architect Consultant
PT. ARSITA INTERKREASI
ARCHITECTURE, INTERIOR, LANDSCAPE
Jl. PULOMAS UTARA BID NO.1 PULOMAS - JAKARTA TIMUR
TELP (62-21) 4892635 47882346 47882313

Konsultan Interior :
Interior Consultant

Konsultan Struktur :
Konsultan Struktur
PT. ADINATA SURYA PRATAMA
ENGINEERING CONSULTANT
Ruko Palazzo Blok F2 NO. 5A7 Bumi Anggrek Jl. Karangasari, Bekasi
Telp. (021) 82757000, 08133997677
E-mail : adinata01@gmail.com, puspojono@yahoo.com

Konsultan M & E :
M & E Consultant
PT. EMSE
KOMPLEK TAMAN KENCANA BLOK E1 NO.20
LINGKAR LUAR CENGKARENG, JAKARTA 11730

Judul gambar :
Drawing Title
DENAH KOLOM

Drawn by	Putut	DATE	18/03/14
Job Captain		DATE	
Project Architect		DATE	
Project Manager		DATE	
Project Director		DATE	
OWNER APPROVAL		DATE	

SCALE 1 : 250

ISSUED FOR	REVISION	DRAWING CODE/NO
CONSTRUCT.	0	S-01.2B
DATE	18/03/14	

FILE :

Notes :

0	Issued For Contructions	7/4/14
NO	REVISION	DATE SIGN

Key Plan :

Proyek :
Project
Hotel Arum Lombok

Pemberi Tugas :
Owner
PT. Mataram Andalas Semesta

APPROVAL :
BY OWNER
Ibu. Intan Fitrianti

Konsultan Arsitek :
Architect Consultant
PT. ARSITA INTERKREASI
ARCHITECTURE, INTERIOR, LANDSCAPE
Jl. PULOMAS UTARA BID NO.1 PULOMAS - JAKARTA TIMUR
TELP (62-21) 4892635 47882346 47882313

Konsultan Interior :
Interior Consultant

Konsultan Struktur :
Konsultan Struktur
PT. ADINATA SURYA PRATAMA
ENGINEERING CONSULTANT
Ruko Palazzo Blok F2 NO. 5&7 Bumi Anegrek Jl. Karangasatira, Bekasi
Telp. (021) 92757000, 081389897077
E-mail : adinatas@ptadina.com, pusaryono@yahoo.com

Konsultan M & E :
M & E Consultant
PT. EMSE
KOMPLEK TAMAN KENCANA BLOK E1 NO.20
LINGKAR LUAR CENGKARENG, JAKARTA 11730

Judul gambar :
Drawing Title
POTONGAN PORTAL - T2 & T3

Drawn By	Putut	DATE	23/03/14
Job Captain		DATE	
Project Architect		DATE	
Project Manager		DATE	
Project Director		DATE	
OWNER APPROVAL		DATE	
SCALE	1 : 250		

ISSUED FOR	REVISION	DRAWING CODE/NO
CONTRACT.	0	S-02.1
DATE	7/4/14	

FILE :

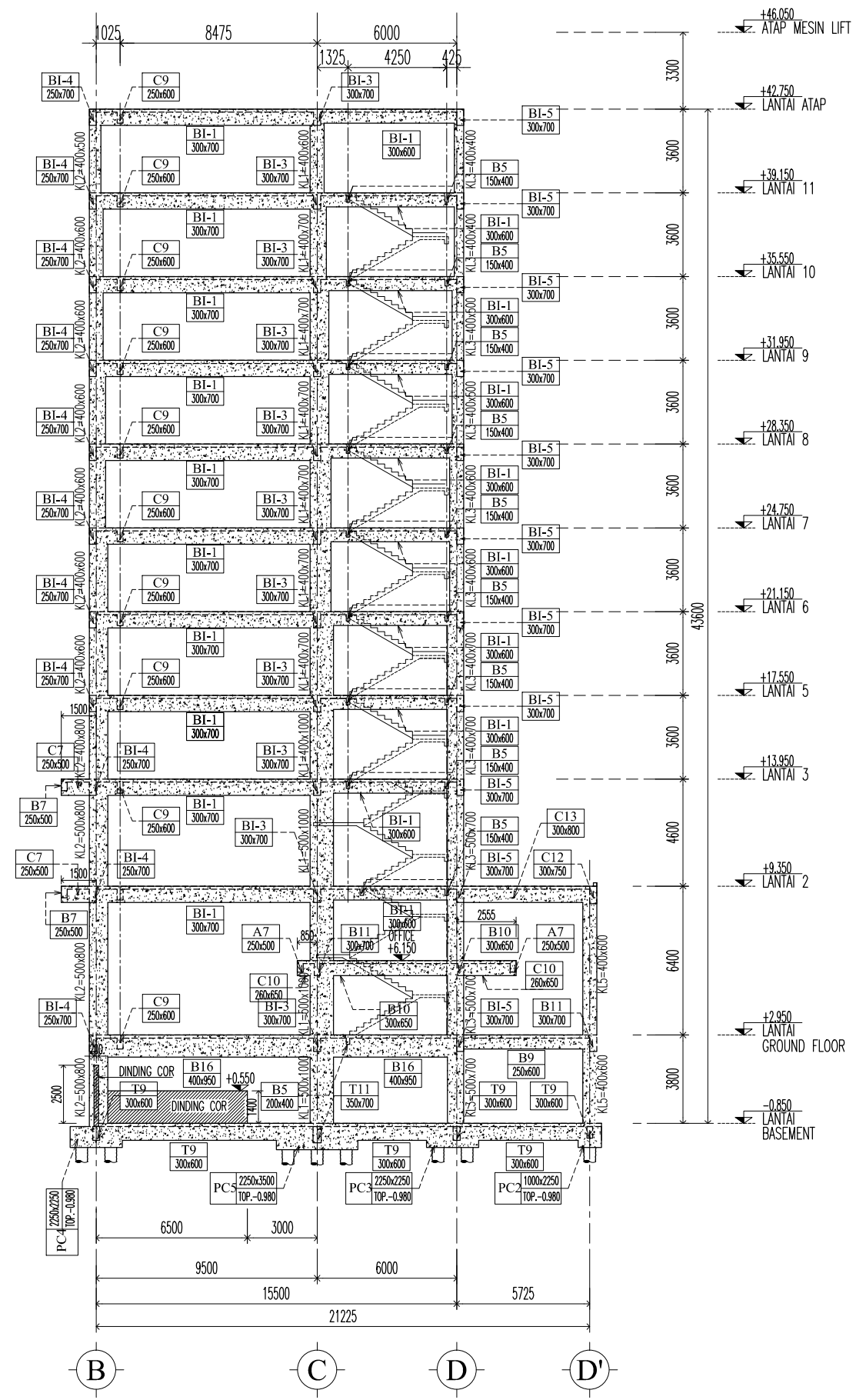

POTONGAN PORTAL T2
SKALA 1:250

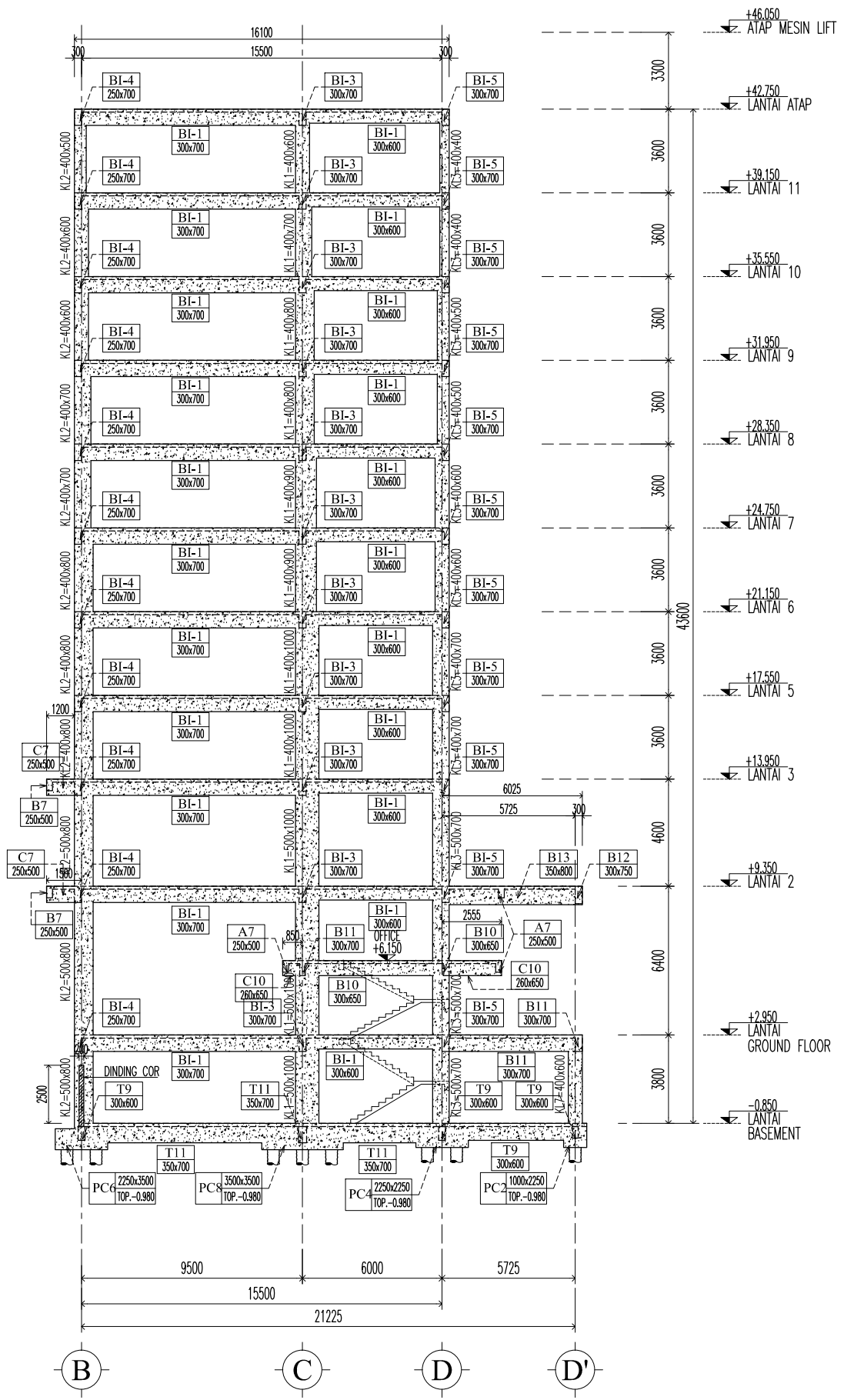

POTONGAN PORTAL T3
SKALA 1:250

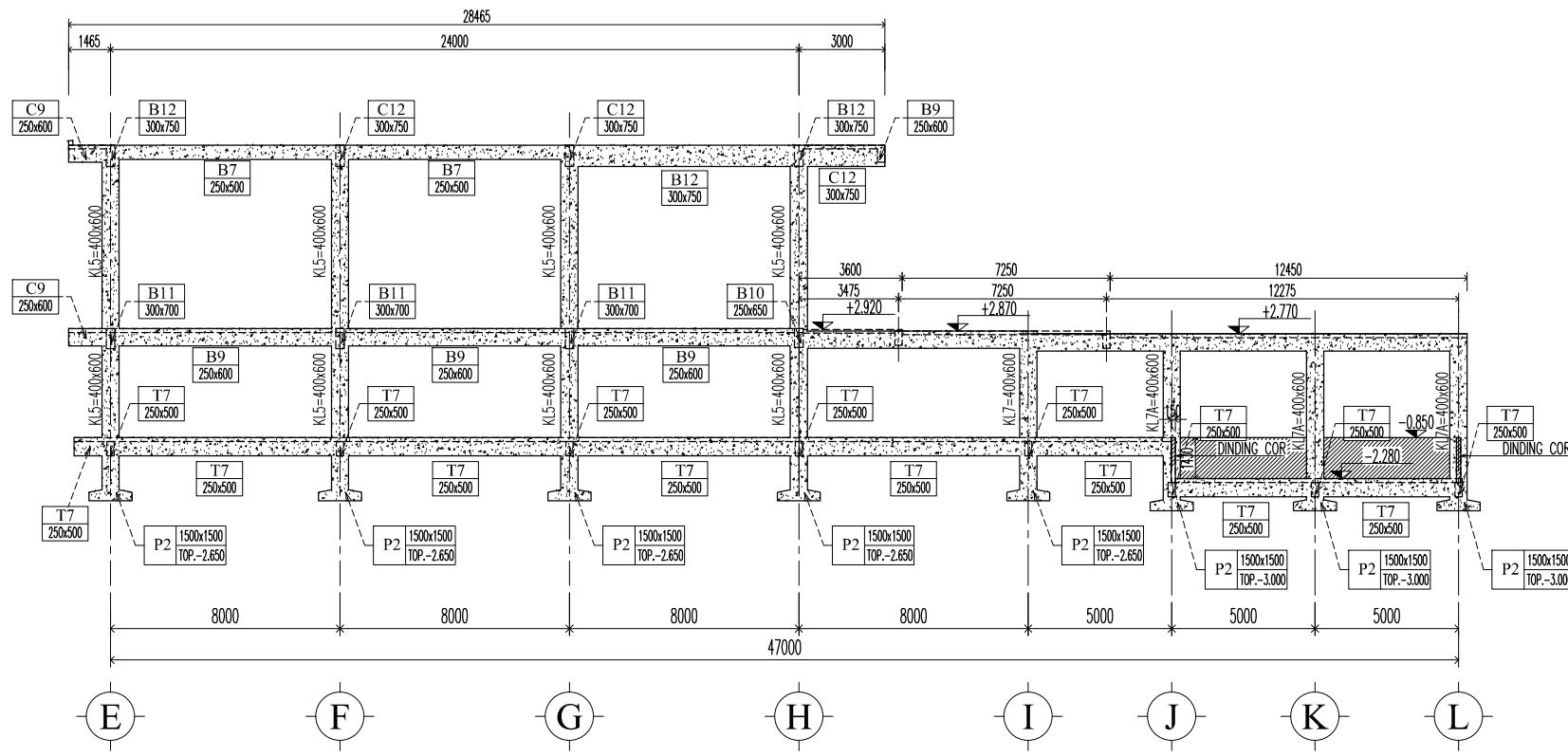

POTONGAN PORTAL 2
SKALA 1:250

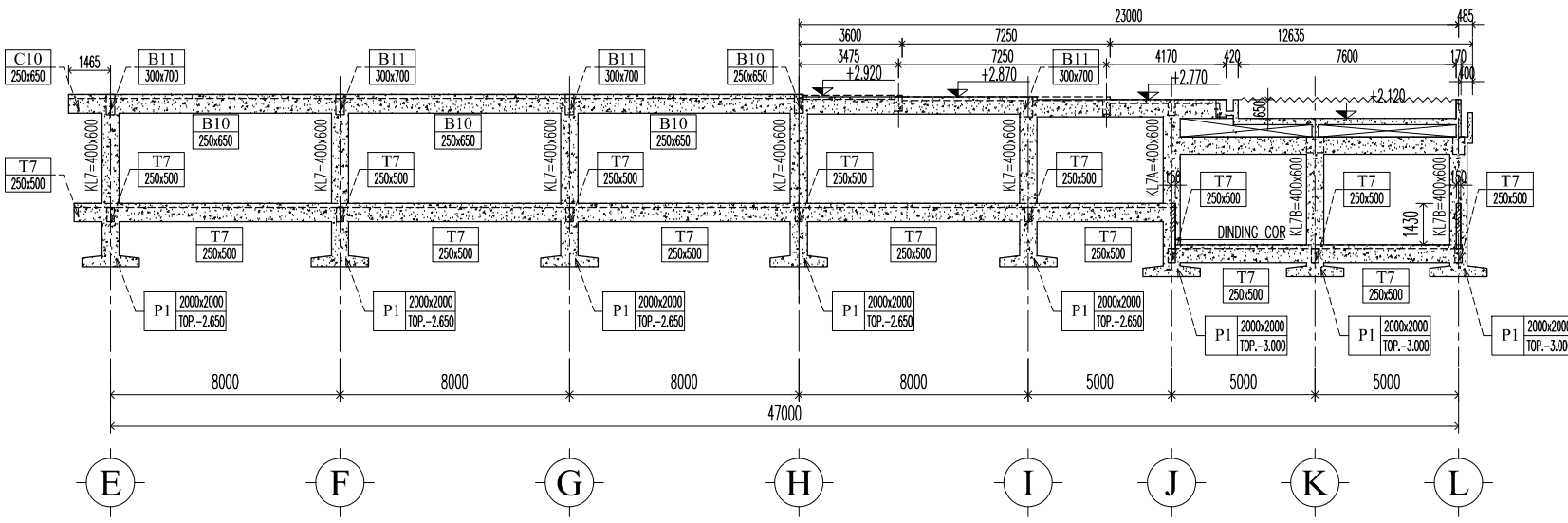
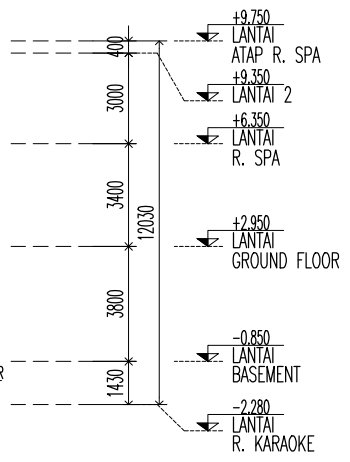

POTONGAN PORTAL 3
SKALA 1:250

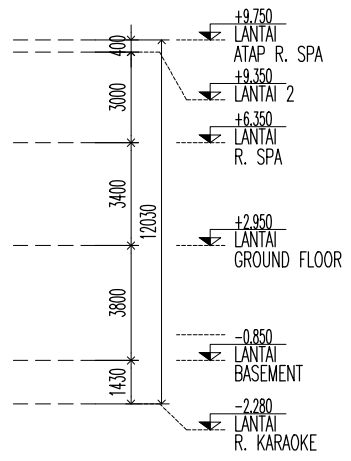

Notes :

0	Issued For Contructions	7/4/14
NO	REVISION	DATE SIGN

Key Plan :

Proyek :
Project Hotel Arum Lombok

Pemberi Tugas :
Owner PT. Mataram Andalas Semesta

APPROVAL :
BY OWNER Ibu. Intan Fitrianti

Konsultan Arsitek :
Architect Consultant
PT. ARSITA INTERKREASI
ARCHITECTURE, INTERIOR, LANDSCAPE
JL. PULOMAS UTARA BID NO.1 PULOMAS - JAKARTA TIMUR
TELP (62-21) 4892635 47882346 47882313

Konsultan Interior :
Interior Consultant

Konsultan Struktur :
Structural Consultant
PT. ADINATA SURYA PRATAMA
ENGINEERING CONSULTANT
Ruko Palazzo Blok P2 NO. 5&7 Bumi Anegrek Jl. Karangsatira, Bekasi
Telp. (021) 92757000, 081389897077
E-mail : adinatas21@gmail.com, pusasyono@yahoo.com

Konsultan M & E :
M & E Consultant
PT. EMSE
KOMPLEK TAMAN KENCANA BLOK E1 NO.20
LINGKAR LUAR CENGKARENG, JAKARTA 11730

Judul gambar :
Drawing Title **POTONGAN PORTAL 2 & 3**

Drawn By	Putut	DATE	23/03/14
Job Captain		DATE	
Project Architect		DATE	
Project Manager		DATE	
Project Director		DATE	
OWNER APPROVAL		DATE	

ISSUED FOR	REVISION	DRAWING CODE/NO
CONTRACT.	0	S-02.5
DATE	7/4/14	

FILE :

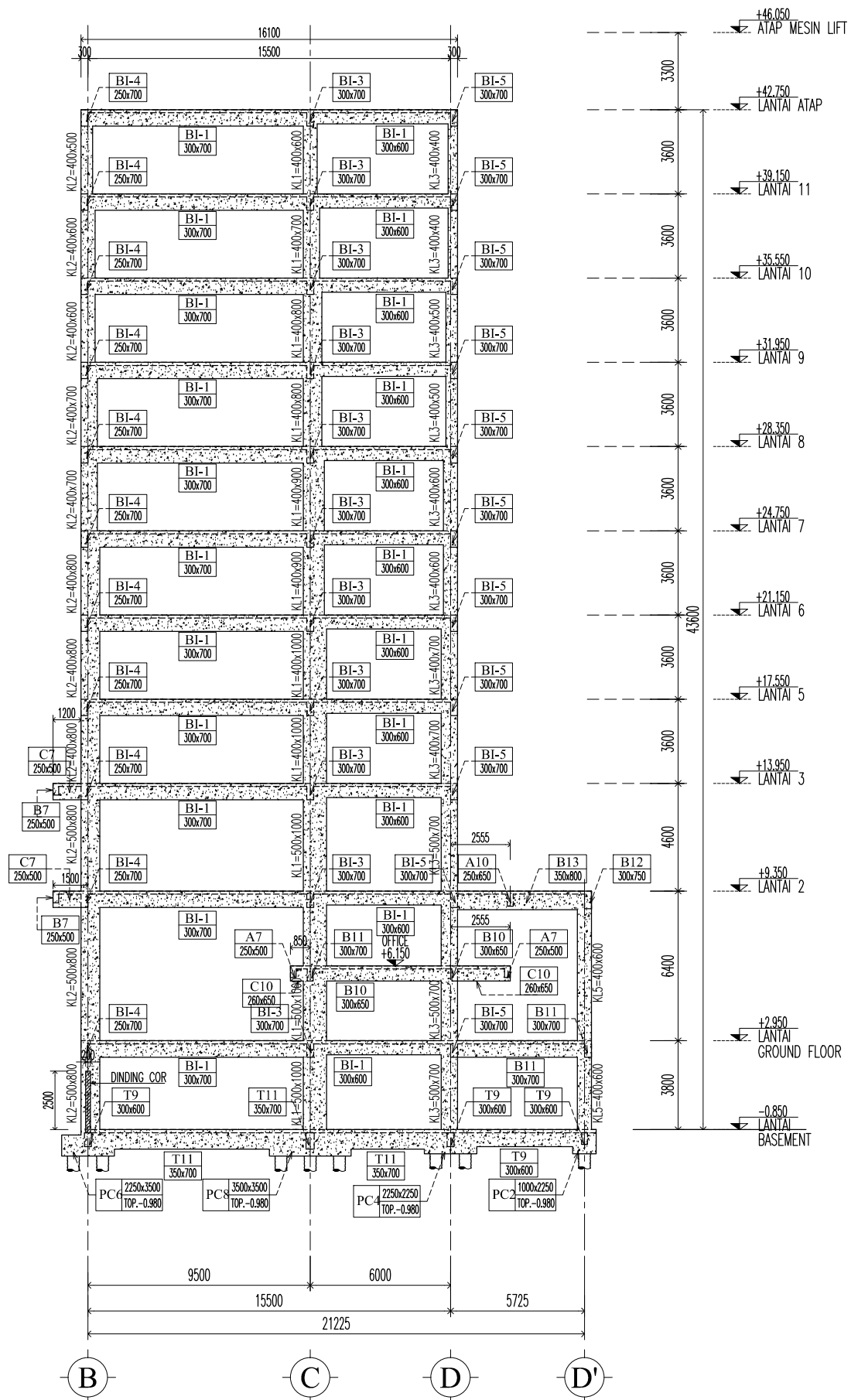

POTONGAN PORTAL T4
SKALA 1:250

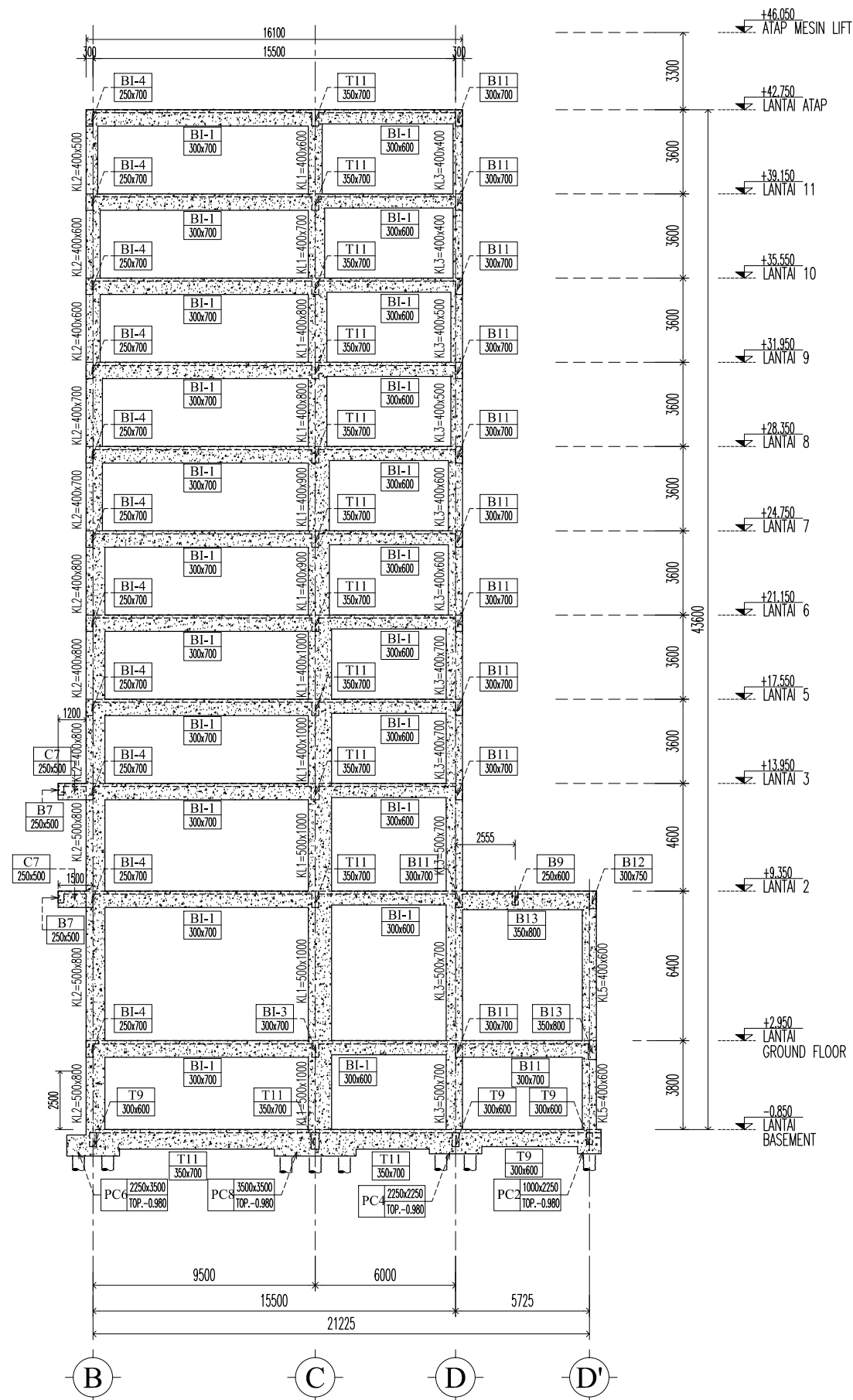

POTONGAN PORTAL T5
SKALA 1:250

Notes :

0	Issued For Contructions	7/4/14
NO	REVISION	DATE SIGN

Key Plan :

Proyek :
Project Hotel Arum Lombok

Pemberi Tugas :
Owner PT. Mataram Andalas Semesta

APPROVAL :
By OWNER Ibu. Intan Fitrianti

Konsultan Arsitek :
Architect Consultant
PT. ARSITA INTERKREASI
ARCHITECTURE, INTERIOR, LANDSCAPE
Jl. PULOAS UTARA BID NO.1 PULOAS - JAKARTA TIMUR
TELP (62-21) 4892635 47882346 47882313

Konsultan Interior :
Interior Consultant

Konsultan Struktur :
Konsultan Struktur
PT. ADINATA SURYA PRATAMA
ENGINEERING CONSULTANT
Ruko Palazzo Blok F2 NO. 5&7 Bumi Anegrek Jl. Karangasatira, Bekasi
Telp. (021) 92757000, 081389897077
E-mail : adinatas1@gmail.com, pusasyono@yahoo.com

Konsultan M & E :
M & E Consultant
PT. EMSE
KOMPLEK TAMAN KENCANA BLOK E1 NO.20
LINGKAR LUAR CENGKARENG, JAKARTA 11730

Judul gambar :
Drawing Title
POTONGAN PORTAL - T4 & T5

Drawn By	Putut	DATE	23/03/14
Job Captain		DATE	
Project Architect		DATE	
Project Manager		DATE	
Project Director		DATE	
OWNER APPROVAL		DATE	

ISSUED FOR	REVISION	DRAWING CODE/NO
CONTRACT.	0	S-02.2

DATE	7/4/14	FILE :
------	--------	--------

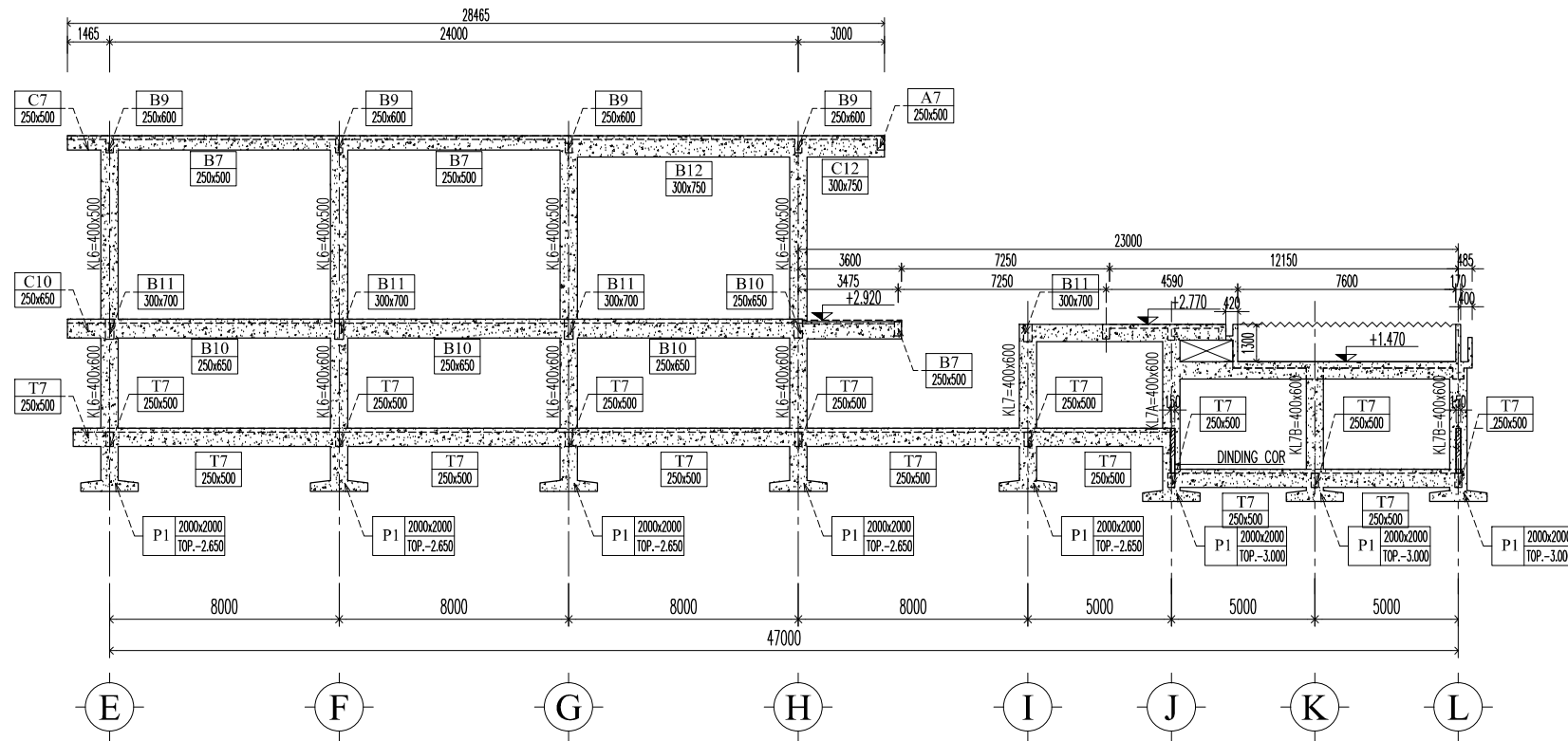

POTONGAN PORTAL 4

SKALA 1:250

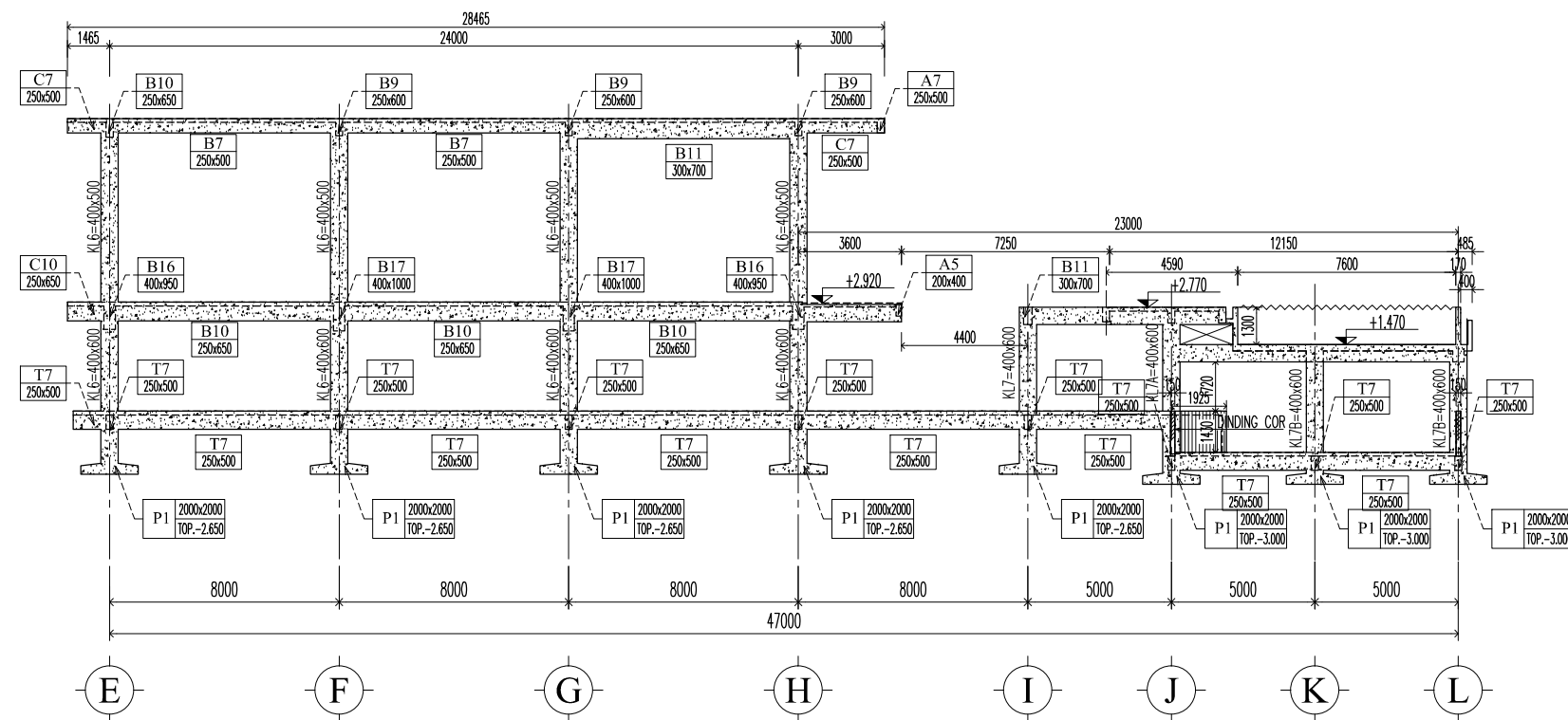
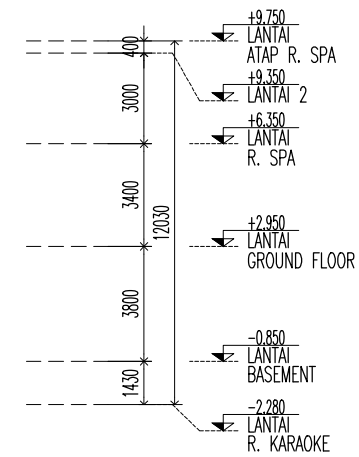

POTONGAN PORTAL 5

SKALA 1:250

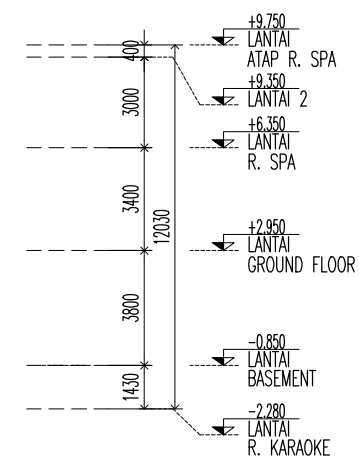

Notes :

0	Issued For Contructions	7/4/14
NO	REVISION	DATE SIGN

Key Plan :

Proyek :
Project Hotel Arum Lombok

Pemberi Tugas :
Owner PT. Mataram Andalas Semesta

APPROVAL :
BY OWNER Ibu. Intan Fitrianti

Konsultan Arsitek :
Architect Consultant
PT. ARSITA INTERKREASI
ARCHITECTURE, INTERIOR, LANDSCAPE
Jl. PULOAS UTARA BID NO.1 PULOAS - JAKARTA TIMUR
TELP (62-21) 4892635 47882346 47882313

Konsultan Interior :
Interior Consultant

Konsultan Struktur :
Konsultan Struktur
PT. ADINATA SURYA PRATAMA
ENGINEERING CONSULTANT
Ruko Palazzo Blok F2 NO. 5&7 Bumi Anegrek Jl. Karangasatna, Bekasi
Telp. (021) 92757000, 081388997077
E-mail : adinatas1@gmail.com, pusasyonyo@yahoo.com

Konsultan M & E :
M & E Consultant
PT. EMSE
KOMPLEK TAMAN KENCANA BLOK E1 NO.20
LINGKAR LUAR CENGKARENG, JAKARTA 11730

Judul gambar :
Drawing Title POTONGAN PORTAL 4 & 5

Drawn By	Putut	DATE	23/03/14
Job Captain		DATE	
Project Architect		DATE	
Project Manager		DATE	
Project Director		DATE	
OWNER APPROVAL		DATE	

SCALE	1 : 250	
ISSUED FOR	REVISION	DRAWING CODE/NO
CONTRACT.	0	S-02.6
DATE	7/4/14	

FILE :

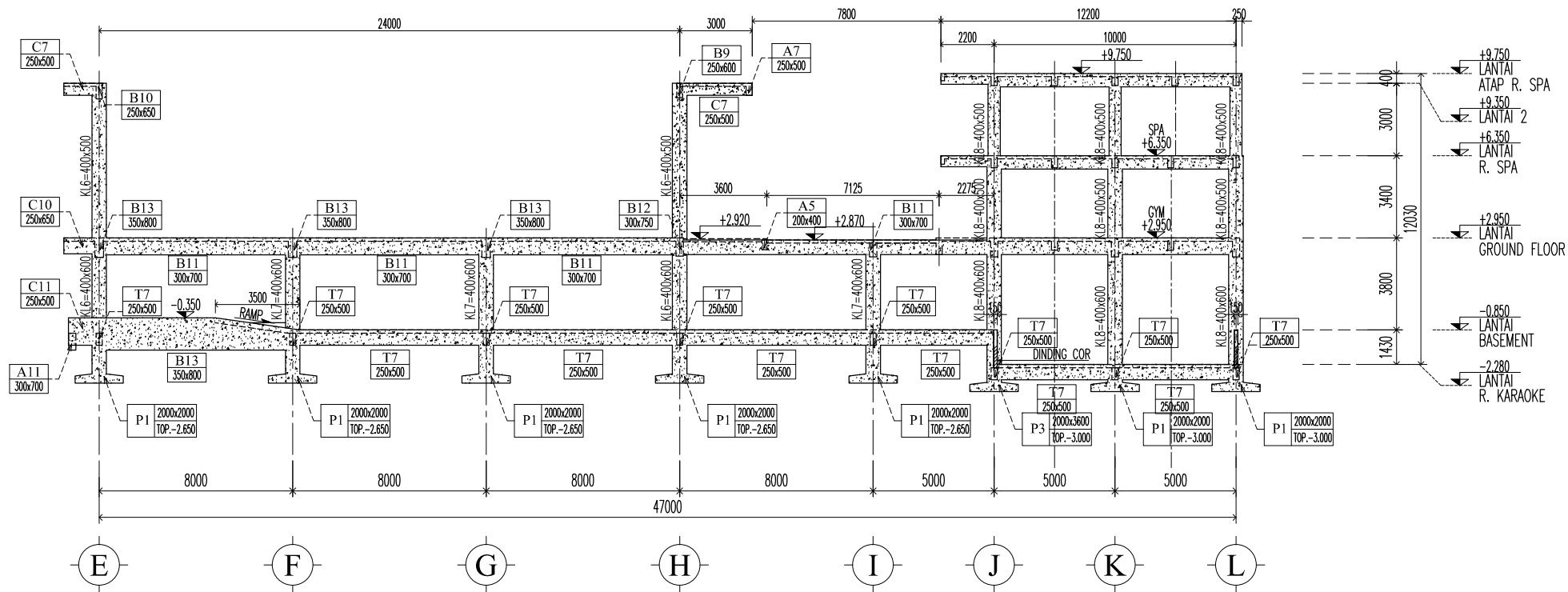

POTONGAN PORTAL 5'

SKALA 1:250

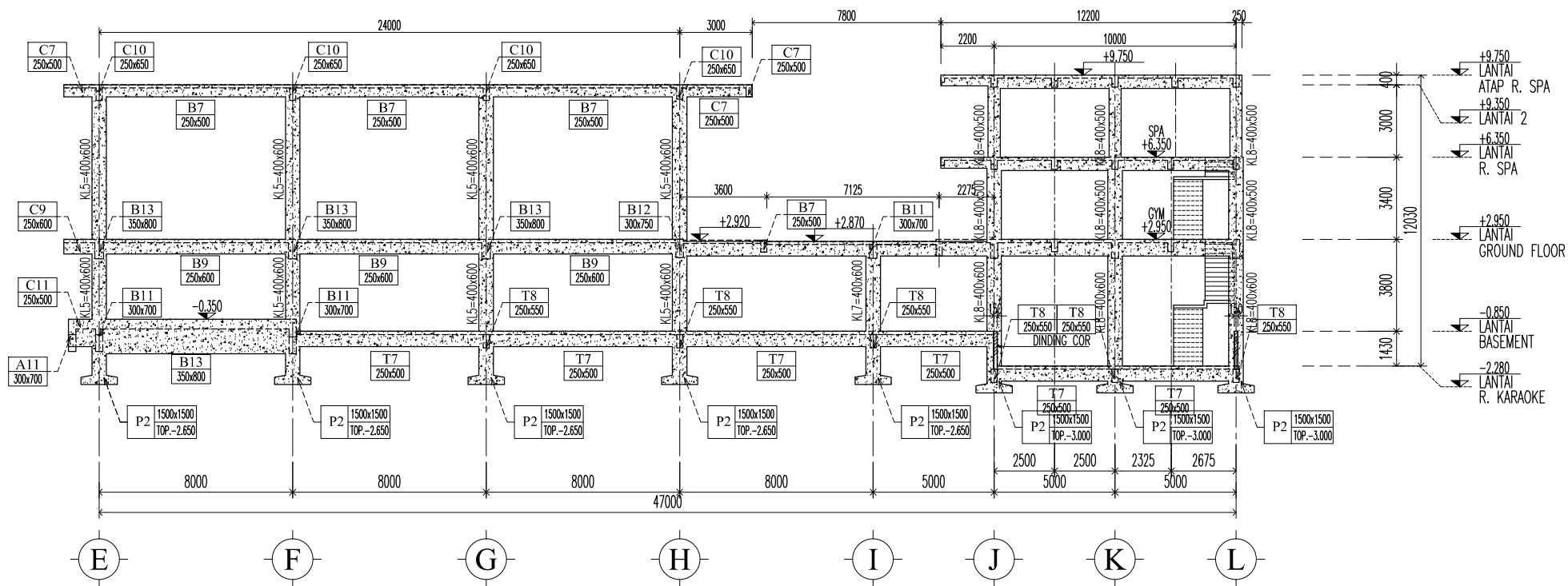

POTONGAN PORTAL 6

SKALA 1:250

Notes :

0	Issued For Contructions	7/4/14
NO	REVISION	DATE SIGN

Key Plan :

Proyek :
Project

Hotel Arum Lombok

Pemberi Tugas :
Owner

PT. Mataram Andalas Semesta

APPROVAL :
BY OWNER

Ibu. Intan Fitrianti

Konsultan Arsitek :
Architect Consultant



Konsultan Interior :
Interior Consultant

Konsultan Struktur :
Konsultan Struktur



Konsultan M & E :
M & E Consultant



Judul gambar :
Drawing Title

POTONGAN PORTAL 5' & 6

Drawn By	Putut	DATE	23/03/14
Job Captain		DATE	
Project Architect		DATE	
Project Manager		DATE	
Project Director		DATE	
OWNER APPROVAL		DATE	

SCALE	1 : 250	
ISSUED FOR	REVISION	DRAWING CODE/NO
CONTRACT.	0	S-02.7
DATE	7/4/14	

FILE :

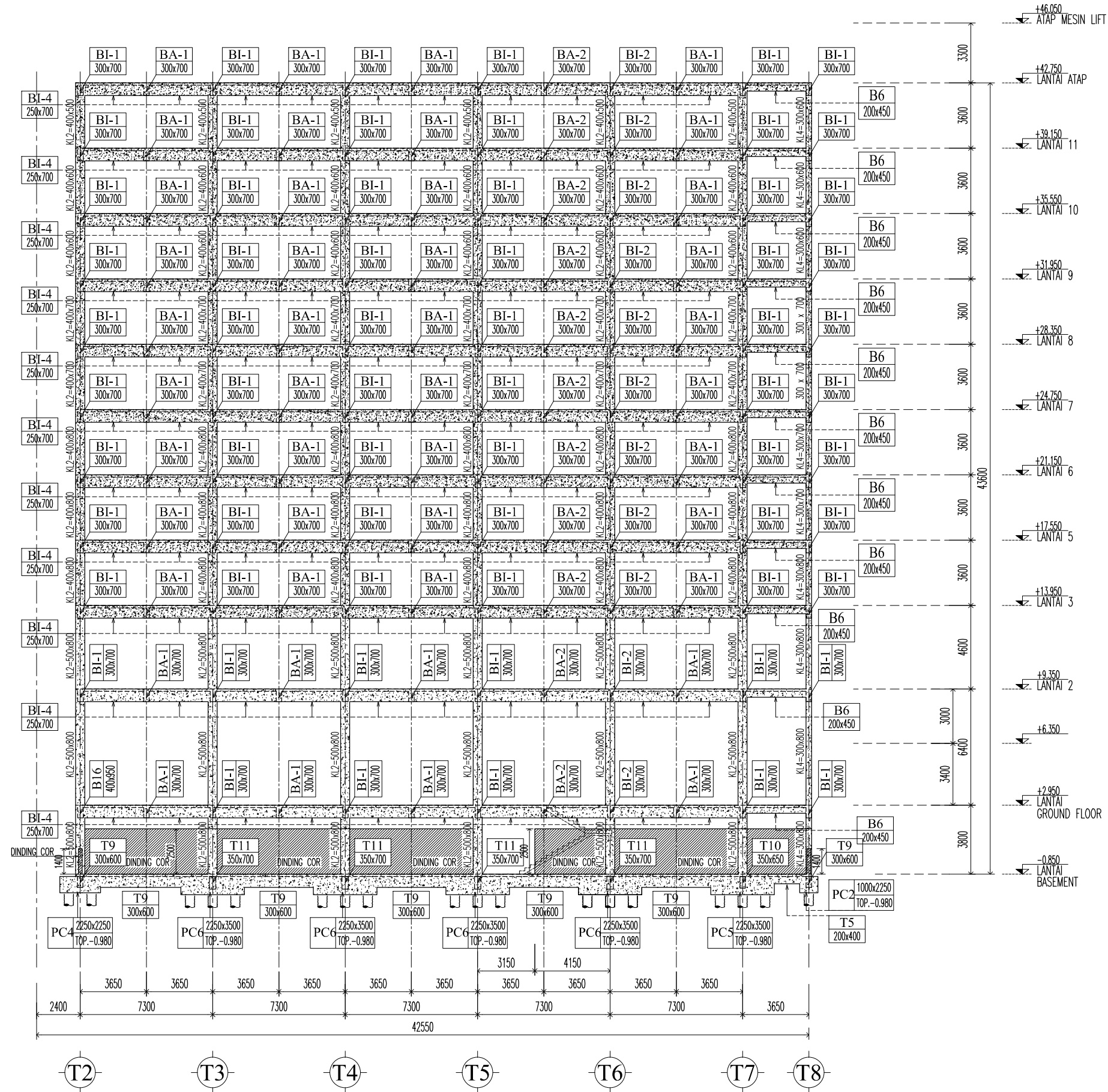

POTONGAN PORTAL - B
SKALA 1:250

Notes :

0	Issued For Contructions	7/4/14
NO	REVISION	DATE SIGN

Key Plan :

Proyek :
Project Hotel Arum Lombok

Pemberi Tugas :
Owner PT. Mataram Andalas Semesta

APPROVAL :
By OWNER Ibu. Intan Fitrianti

Konsultan Arsitek :
Architect Consultant
PT. ARSITA INTERKREASI
ARCHITECTURE, INTERIOR, LANDSCAPE
Jl. PULOAS UTARA BID NO.1 PULOAS - JAKARTA TIMUR
Telp. (021) 92757800, 081389997077
E-mail : arsitain@pt.com, pusaryono@yahoo.com

Konsultan Interior :
Interior Consultant

Konsultan Struktur :
Konsultan Struktur
PT. ADINATA SURYA PRATAMA
ENGINEERING CONSULTANT
Ruko Palazzo Blok F2 NO. 5&7 Bumi Anjgrek, Jl. Karangasatira, Bekasi
Telp. (021) 92757800, 081389997077
E-mail : adinatas1@gmail.com, pusaryono@yahoo.com

Konsultan M & E :
M & E Consultant
PT. EMSE
KOMPLEK TAMAN KENCANA BLOK E1 NO.20
LINGKAR LUAR CENGKARENG, JAKARTA 11730

Judul gambar :
Drawing Title POTONGAN PORTAL - B

Drawn By	Putut	DATE	23/03/14
Job Captain		DATE	
Project Architect		DATE	
Project Manager		DATE	
Project Director		DATE	
OWNER APPROVAL		DATE	
SCALE	1 : 250		

ISSUED FOR	REVISION	DRAWING CODE/NO
------------	----------	-----------------

CONTRACT.	0	S-02.8
DATE	7/4/14	

FILE :

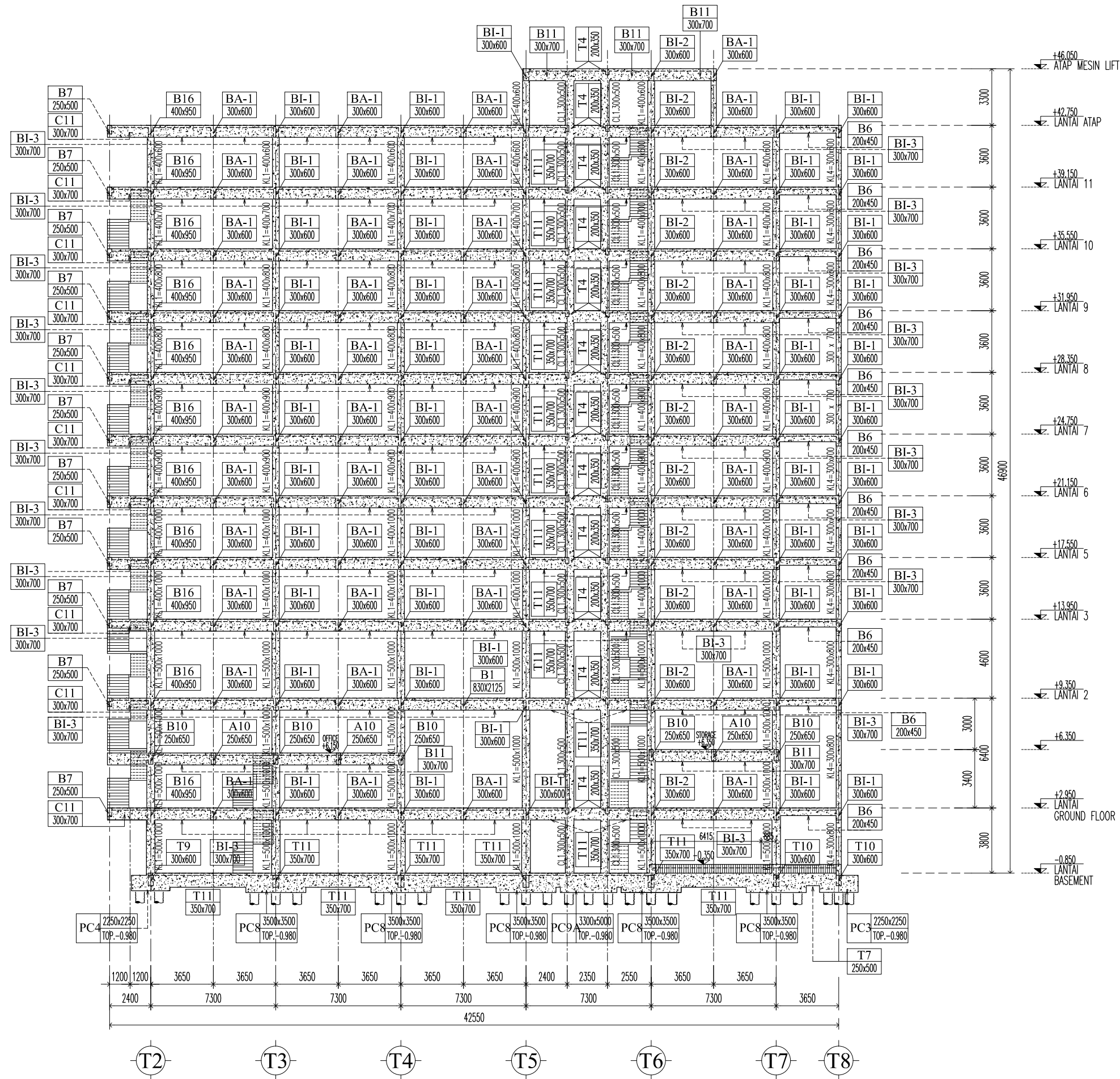

POTONGAN PORTAL - C
SKALA 1:250

Notes :

0	Issued For Contructions	7/4/14
NO	REVISION	DATE SIGN

Key Plan :

Proyek :
Project Hotel Arum Lombok

Pemberi Tugas :
Owner PT. Mataram Andalas Semesta

APPROVAL :
By OWNER Ibu. Intan Fitrianti

Konsultan Arsitek :
Architect Consultant
PT. ARSITA INTERKREASI
ARCHITECTURE, INTERIOR, LANDSCAPE
JL. PULOMAS UTARA BID NO.1 PULOMAS - JAKARTA TIMUR
TELP (62-21) 4892635 47882346 47882313

Konsultan Interior :
Interior Consultant

Konsultan Struktur :
Konsultan Struktur
PT. ADINATA SURYA PRATAMA
ENGINEERING CONSULTANT
Ruko Palazzo Blok F2 NO. 5&7 Bumi Anegrek Jl. Karangsatia, Bekasi
Telp. (021) 92757000, 081389897077
E-mail : adinatas1@gmail.com, pusaryono@yahoo.com

Konsultan M & E :
M & E Consultant
PT. EMSE
KOMPLEK TAMAN KENCANA BLOK E1 NO.20
LINGKAR LUAR CENGKARENG, JAKARTA 11730

Judul gambar :
Drawing Title POTONGAN PORTAL - C

Drawn By	Putut	DATE	23/03/14
Job Captain		DATE	
Project Architect		DATE	
Project Manager		DATE	
Project Director		DATE	
OWNER APPROVAL		DATE	
SCALE	1 : 250		

ISSUED FOR	REVISION	DRAWING CODE/NO
CONTRACT.	0	S-02.9
DATE	7/4/14	

FILE :

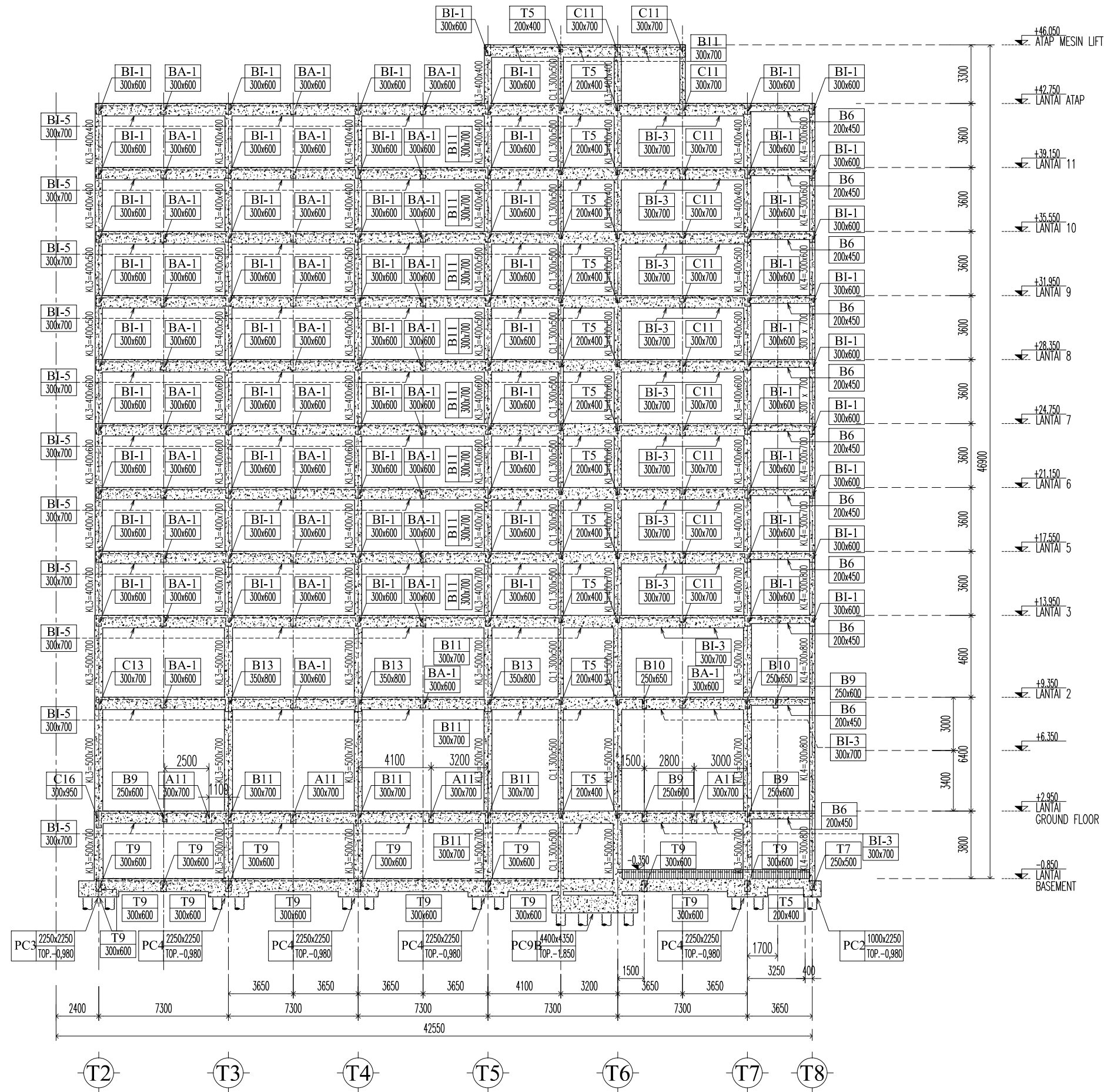

POTONGAN PORTAL - D
SKALA 1:250

Notes :

0	Issued For Contructions	7/4/14
NO	REVISION	DATE SIGN

Key Plan :

Proyek :
Project Hotel Arum Lombok

Pemberi Tugas :
Owner PT. Mataram Andalas Semesta

APPROVAL :
By OWNER Ibu. Intan Fitrianti

Konsultan Arsitek :
Architect Consultant
PT. ARSITA INTERKREASI
ARCHITECTURE, INTERIOR, LANDSCAPE
JL. PULOMAS UTARA BID NO.1 PULOMAS - JAKARTA TIMUR
TELP (62-21) 4892635 47882346 47882313

Konsultan Interior :
Interior Consultant

Konsultan Struktur :
Konsultan Struktur
PT. ADINATA SURYA PRATAMA
ENGINEERING CONSULTANT
Ruko Palazzo Blok F2 NO. 5&7 Bumi Anugerah Jl. Karangasatira, Bekasi
Telp. (021) 92757000, 081389897077
E-mail : adinatas1@gmail.com, pusasyono@yahoo.com

Konsultan M & E
M & E Consultant
PT. EMSE
KOMPLEK TAMAN KENCANA BLOK E1 NO.20
LINGKAR LUAR CENGKARENG, JAKARTA 11730

Judul gambar :
Drawing Title POTONGAN PORTAL - D

Drawn By	Putut	DATE	23/03/14
Job Captain		DATE	
Project Architect		DATE	
Project Manager		DATE	
Project Director		DATE	
OWNER APPROVAL		DATE	
SCALE	1 : 250		

ISSUED FOR	REVISION	DRAWING CODE/NO
CONTRACT.	0	S-02.10
DATE	7/4/14	

FILE :

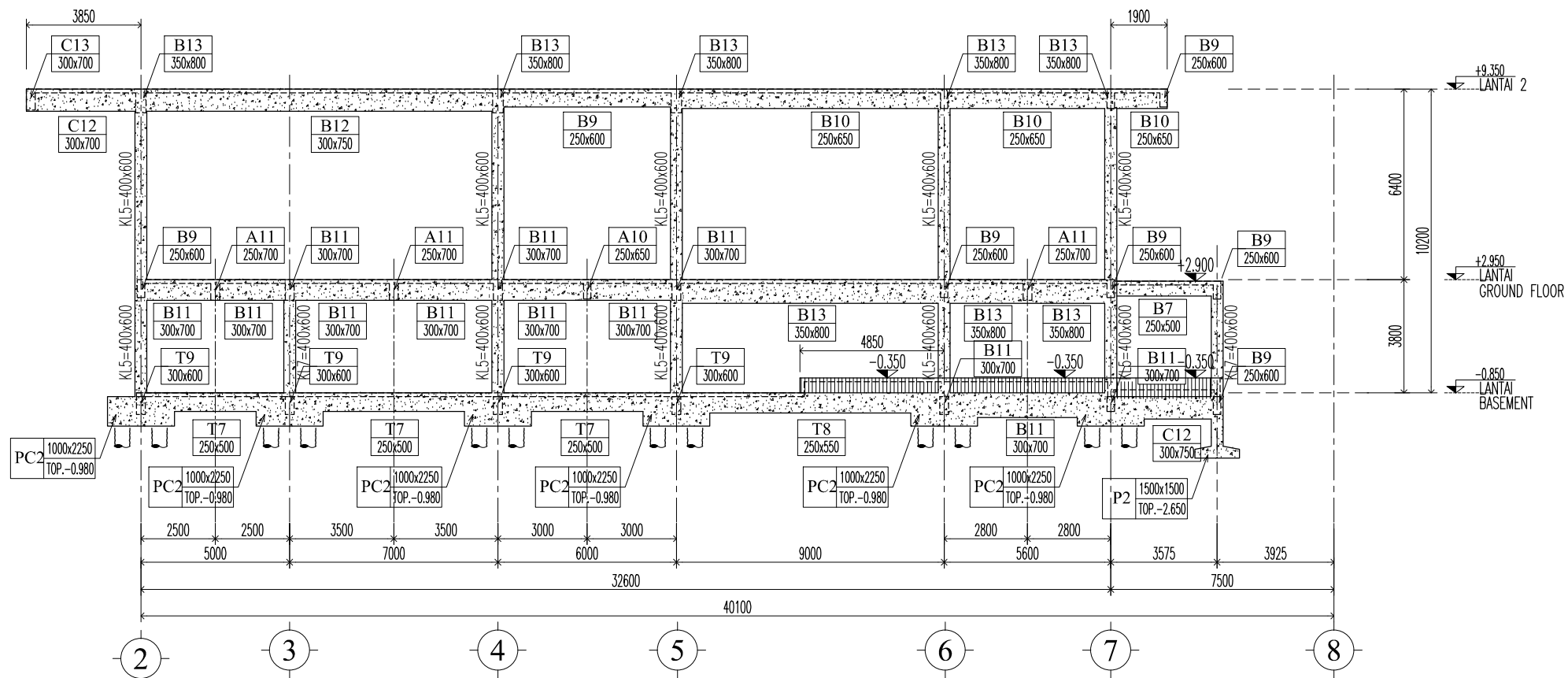

POTONGAN PORTAL - D'
SKALA 1:200

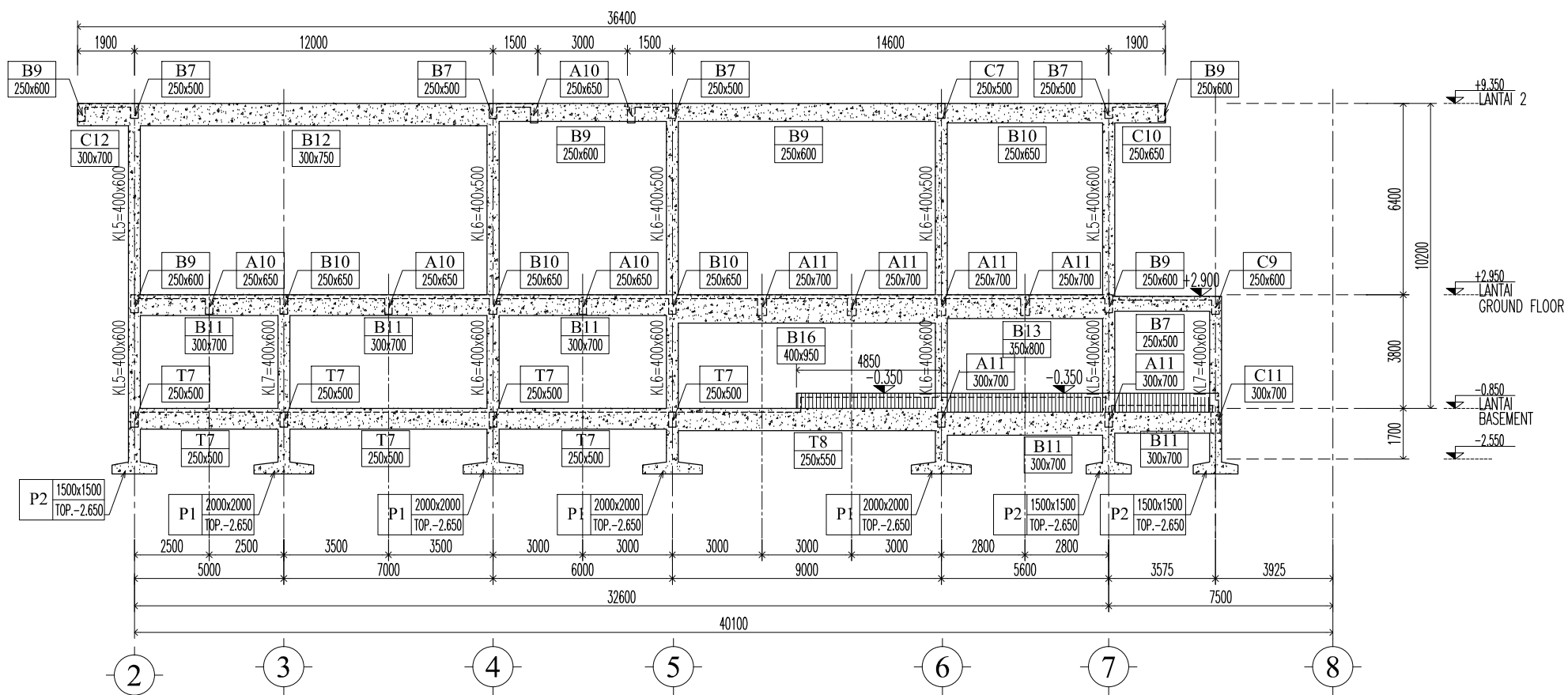

POTONGAN PORTAL - E
SKALA 1:200

Notes :

0	Issued For Contructions	7/4/14
NO	REVISION	DATE SIGN

Key Plan :

Proyek :
Project Hotel Arum Lombok

Pemberi Tugas :
Owner PT. Mataram Andalas Semesta

APPROVAL :
BY OWNER Ibu. Intan Fitrianti

Konsultan Arsitek :
Architect Consultant
PT. ARSITA INTERKREASI
ARCHITECTURE, INTERIOR, LANDSCAPE
Jl. PULOAS UTARA BID NO.1 PULOAS - JAKARTA TIMUR
Telp. (021) 92757000, 081389897877
E-mail : arsitainterkreasit@gmail.com, pusapryono@yahoo.com

Konsultan Interior :
Interior Consultant

Konsultan Struktur :
Konsultan Struktur
PT. ADINATA SURYA PRATAMA
ENGINEERING CONSULTANT
Ruko Palazzo Blok F2 NO. 5&7 Bumi Anjgrek Jl. Karangasatira , Bekasi
Telp. (021) 92757000, 081389897877
E-mail : adinatas01@gmail.com, pusapryono@yahoo.com

Konsultan M & E :
M & E Consultant
PT. EMSE
KOMPLEK TAMAN KENCANA BLOK E1 NO.20
LINGKAR LUAR CENGKARENG, JAKARTA 11730

Judul gambar :
Drawing Title
POTONGAN PORTAL - D' & PORTAL E

Drawn By	Putut	DATE	23/03/14
Job Captain		DATE	
Project Architect		DATE	
Project Manager		DATE	
Project Director		DATE	
OWNER APPROVAL		DATE	

ISSUED FOR	REVISION	DRAWING CODE/NO
CONTRACT.	0	S-02.11

DATE	7/4/14	FILE :
------	--------	--------

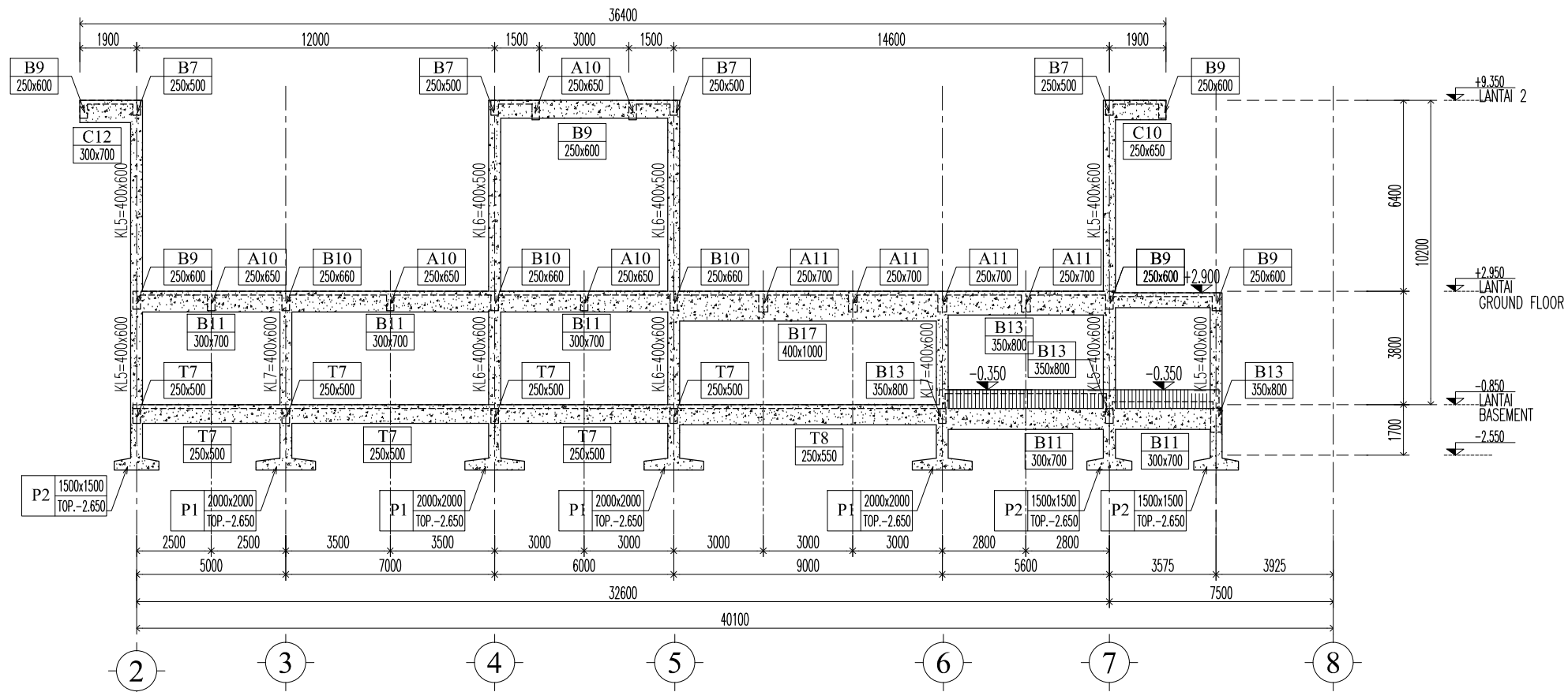

POTONGAN PORTAL - F
SKALA 1:200

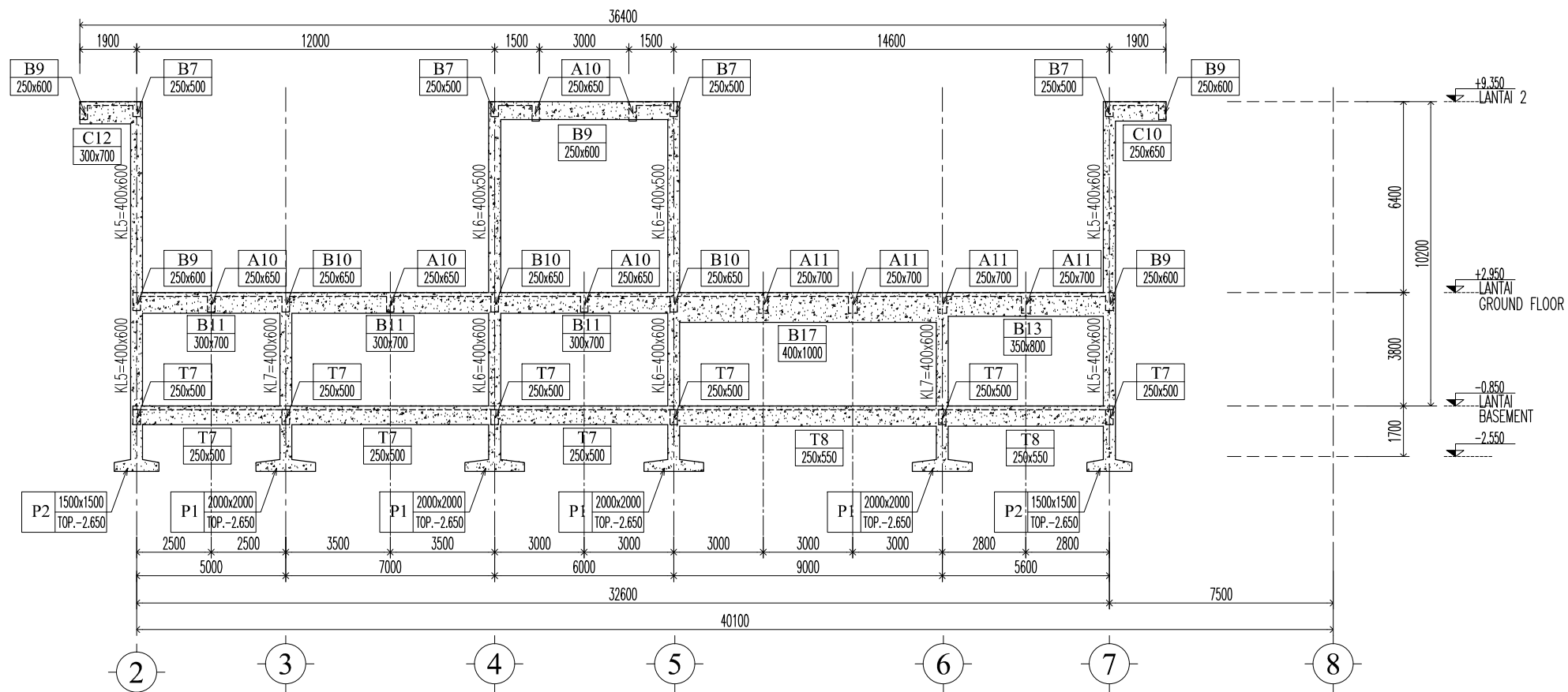

POTONGAN PORTAL - G
SKALA 1:200

Notes :

0	Issued For Contructions	7/4/14
NO	REVISION	DATE SIGN

Key Plan :

Proyek :
Project Hotel Arum Lombok

Pemberi Tugas :
Owner PT. Mataram Andalas Semesta

APPROVAL :
BY OWNER Ibu. Intan Fitrianti

Konsultan Arsitek :
Architect Consultant
PT. ARSITA INTERKREASI
ARCHITECTURE, INTERIOR, LANDSCAPE
Jl. PULOAS UTARA BID NO.1 PULOAS - JAKARTA TIMUR
Telp. (021) 92757000, 081389897877
E-mail : arsitainterkreasit1@gmail.com, pusapryono@yahoo.com

Konsultan Interior :
Interior Consultant

Konsultan Struktur :
Konsultan Struktur
PT. ADINATA SURYA PRATAMA
ENGINEERING CONSULTANT
Ruko Palazzo Blok P2 NO. 5&7 Bumi Anegrek Jl. Karangasatira , Bekasi
Telp. (021) 92757000, 081389897877
E-mail : adinatas1@gmail.com, pusapryono@yahoo.com

Konsultan M & E :
M & E Consultant
PT. EMSE
KOMPLEK TAMAN KENCANA BLOK E1 NO.20
LINGKAR LUAR CENGKARENG, JAKARTA 11730

Judul gambar :
Drawing Title
POTONGAN PORTAL - F & PORTAL G

Drawn By	Putut	DATE	23/03/14
Job Captain		DATE	
Project Architect		DATE	
Project Manager		DATE	
Project Director		DATE	
OWNER APPROVAL		DATE	

SCALE	1 : 200	
ISSUED FOR	REVISION	DRAWING CODE/NO
CONTRACT.	0	S-02.12
DATE	7/4/14	

FILE :

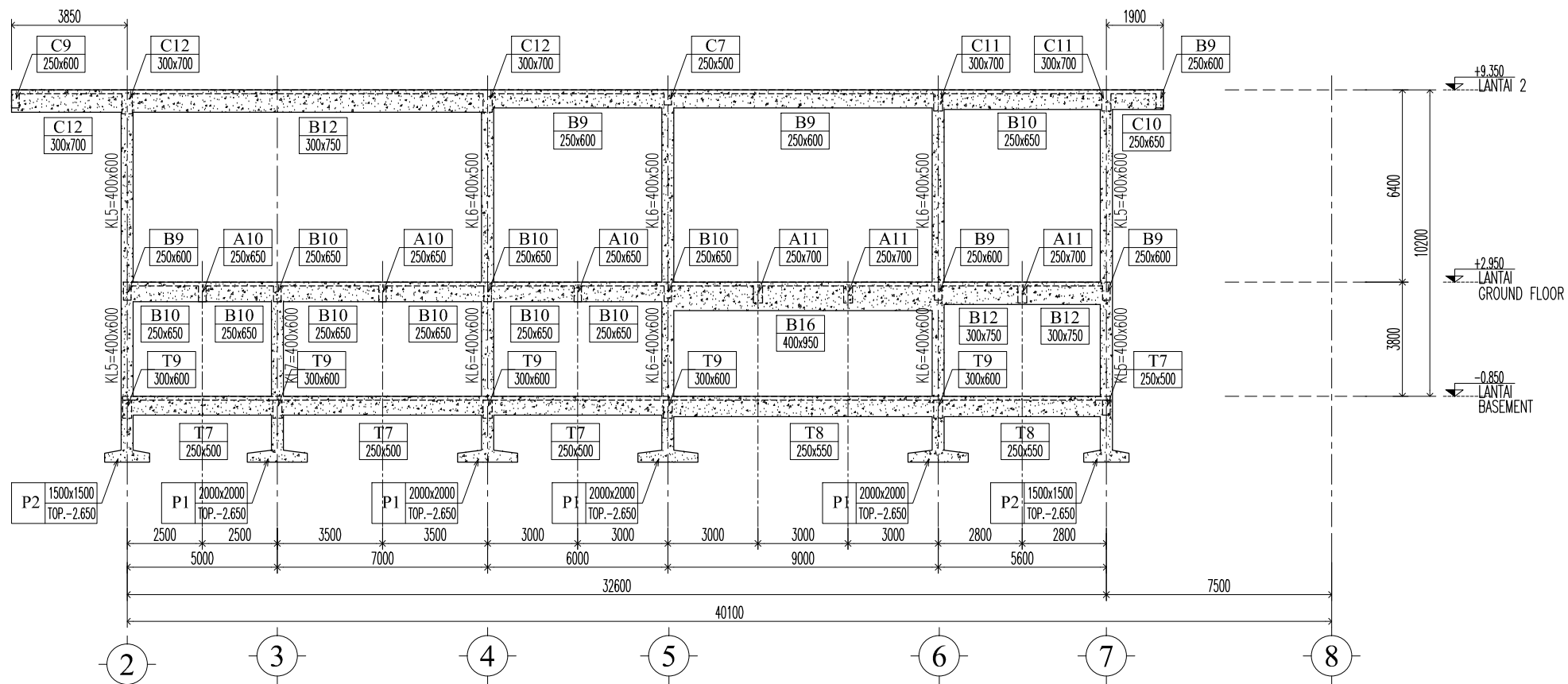

POTONGAN PORTAL - H
SKALA 1:200

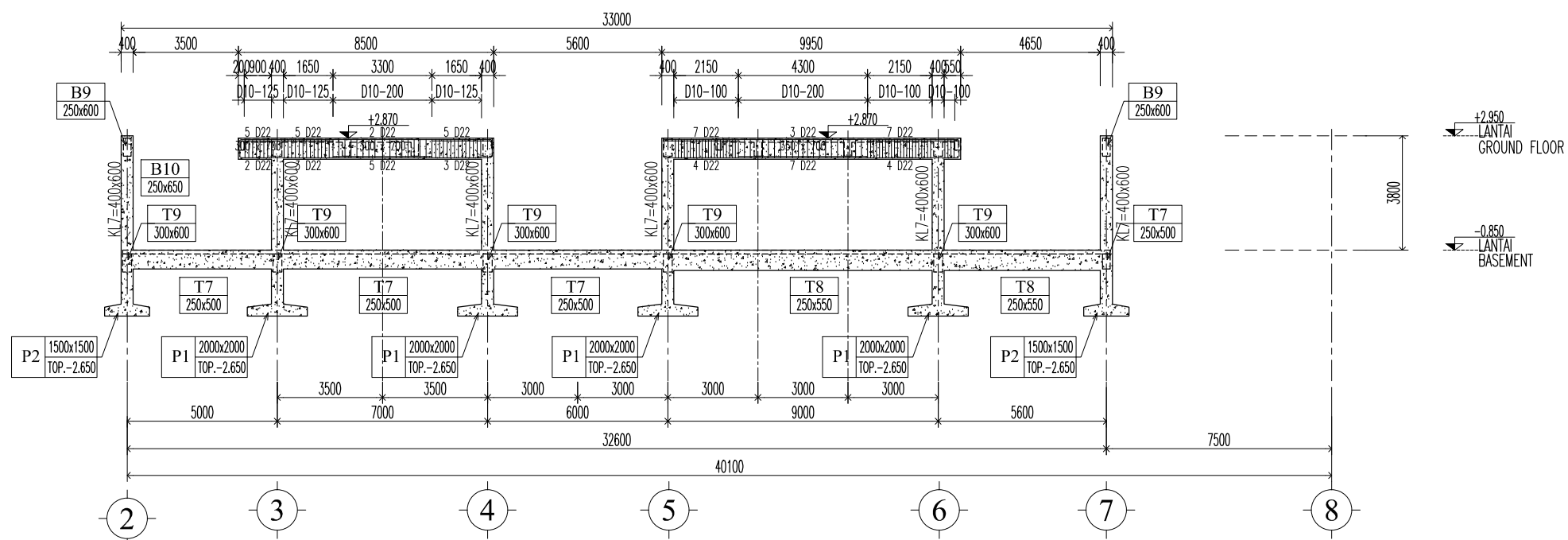

POTONGAN PORTAL - I
SKALA 1:200

Notes :

0	Issued For Contractions	7/4/14
NO	REVISION	DATE SIGN

Key Plan :

Proyek :
Project Hotel Arum Lombok

Pemberi Tugas :
Owner PT. Mataram Andalas Semesta

APPROVAL :
BY OWNER Ibu. Intan Fitrianti

Konsultan Arsitek :
Architect Consultant
PT. ARSITA INTERKREASI
ARCHITECTURE, INTERIOR, LANDSCAPE
JL. PULOMAS UTARA BID NO.1 PULOMAS - JAKARTA TIMUR
TELP (62-21) 4892635 47882346 47882313

Konsultan Interior :
Interior Consultant

Konsultan Struktur :
Konsultan Struktur
PT. ADINATA SURYA PRATAMA
ENGINEERING CONSULTANT
Ruko Palazzo Blok P2 NO. 5&7 Bumi Anegrek Jl. Karangasatira, Bekasi
Telp. (021) 92757000, 081388997877
E-mail : adinatas1@gmail.com, pusasyono@yahoo.com

Konsultan M & E :
M & E Consultant
PT. EMSE
KOMPLEK TAMAN KENCANA BLOK E1 NO.20
LINGKAR LUAR CENGKARENG, JAKARTA 11730

Judul gambar :
Drawing Title POTONGAN PORTAL - H & PORTAL I

Drawn By	Putut	DATE	23/03/14
Job Captain		DATE	
Project Architect		DATE	
Project Manager		DATE	
Project Director		DATE	
OWNER APPROVAL		DATE	

SCALE	1 : 200	
ISSUED FOR	REVISION	DRAWING CODE/NO
CONTRACT.	0	S-02.13
DATE	7/4/14	

FILE :

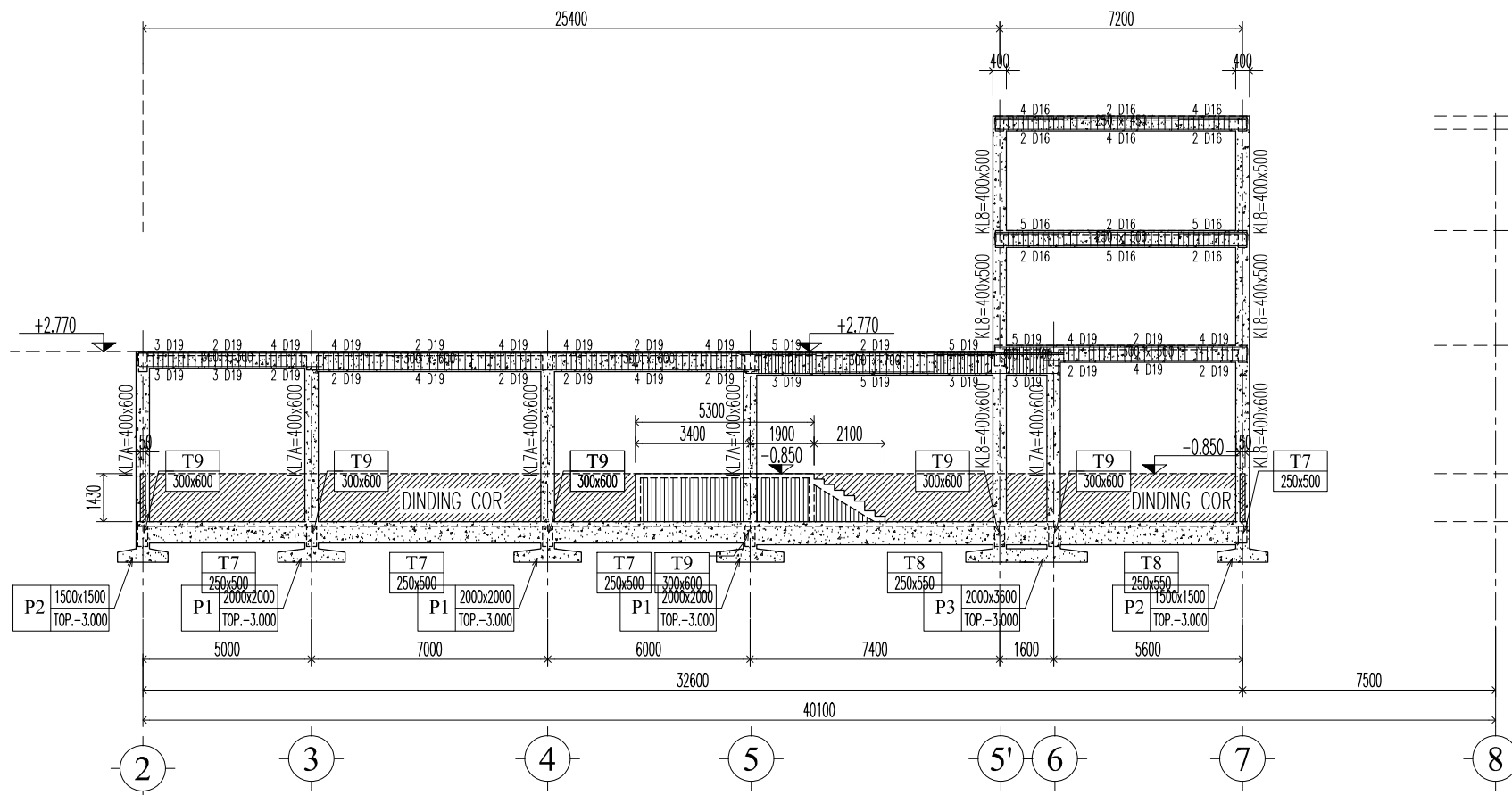

POTONGAN PORTAL - J

SKALA 1:200

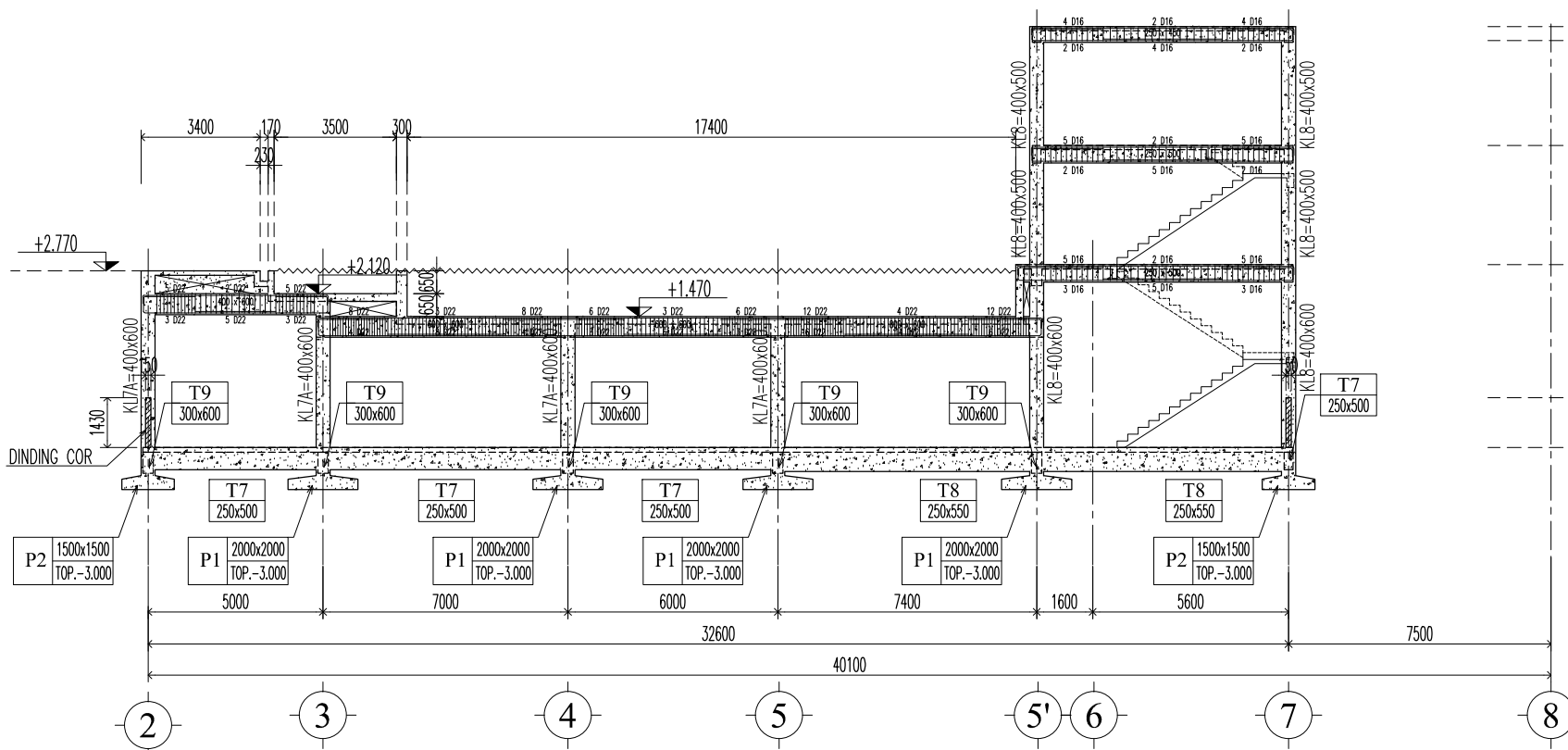

POTONGAN PORTAL - K

SKALA 1:200

Notes :

0	Issued For Contructions	7/4/14
NO	REVISION	DATE SIGN

Key Plan :

Proyek :
Project Hotel Arum Lombok

Pemberi Tugas :
Owner PT. Mataram Andalas Semesta

APPROVAL :
BY OWNER Ibu. Intan Fitrianti

Konsultan Arsitek :
Architect Consultant
PT. ARSITA INTERKREASI
ARCHITECTURE, INTERIOR, LANDSCAPE
Jl. PULOMAS UTARA BID NO.1 PULOMAS - JAKARTA TIMUR
TELP (62-21) 4892635 47882346 47882313

Konsultan Interior :
Interior Consultant

Konsultan Struktur :
Konsultan Struktur
PT. ADINATA SURYA PRATAMA
ENGINEERING CONSULTANT
Ruko Palazzo Blok P2 NO. 5&7 Bumi Anegrek Jl. Karangsatira, Bekasi
Telp. (021) 92757000, 081389897877
E-mail : adinatas1@gmail.com, pusasyonyo@yahoo.com

Konsultan M & E :
M & E Consultant
PT. EMSE
KOMPLEK TAMAN KENCANA BLOK E1 NO.20
LINGKAR LUAR CENGKARENG, JAKARTA 11730

Judul gambar :
Drawing Title
POTONGAN PORTAL - J & PORTAL K

Drawn By	Putut	DATE	23/03/14
Job Captain		DATE	
Project Architect		DATE	
Project Manager		DATE	
Project Director		DATE	
OWNER APPROVAL		DATE	

SCALE	1 : 200	
ISSUED FOR	REVISION	DRAWING CODE/NO
CONTRACT.	0	S-02.14
DATE	7/4/14	

FILE :

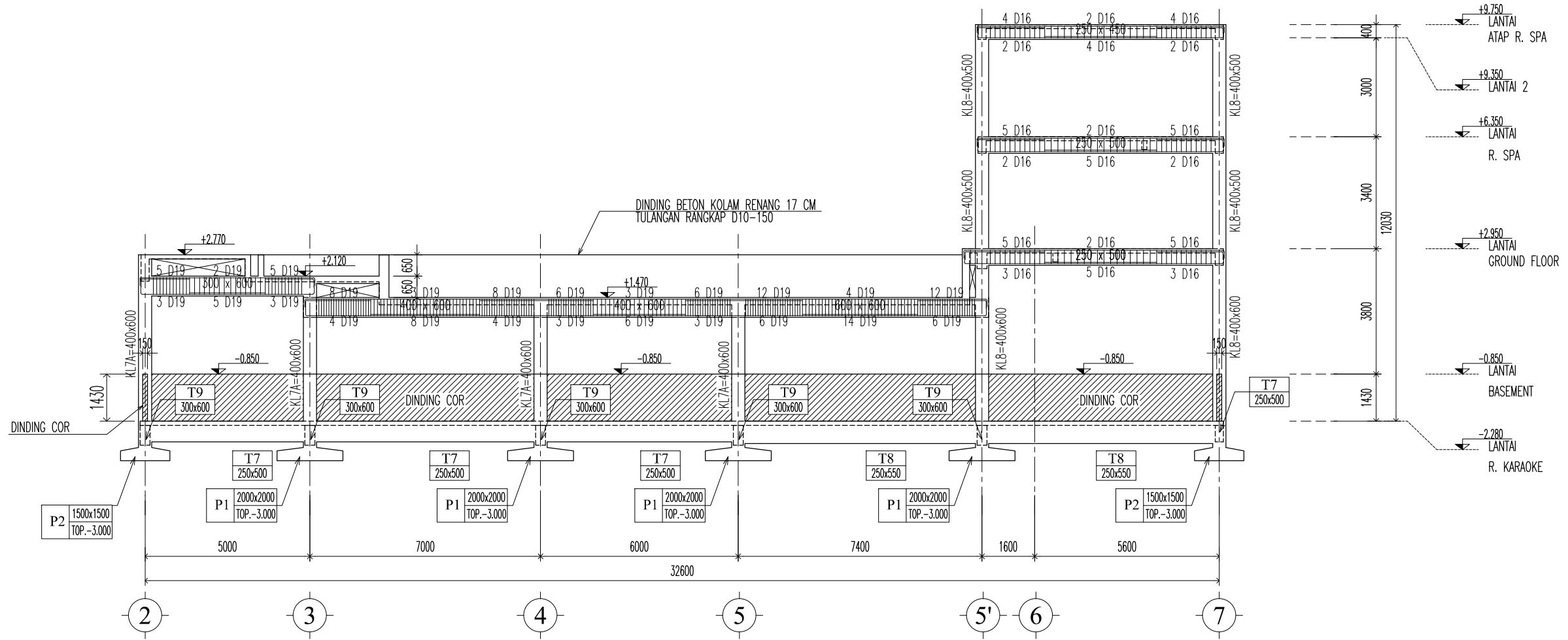

POTONGAN PORTAL - L
SKALA 1:150

Notes :

0	Issued For Contructions	7/4/14
NO	REVISION	DATE SIGN

Key Plan :

Proyek :
Project Hotel Arum Lombok

Pemberi Tugas :
Owner PT. Mataram Andalas Semesta

APPROVAL :
BY OWNER
Ibu. Intan Fitrianti

Konsultan Arsitek :
Architect Consultant
PT. ARSITA INTERKREASI
ARCHITECTURE, INTERIOR, LANDSCAPE
JL. PULOAS UTARA BID NO.1 PULOAS - JAKARTA TIMUR
TELP (62-21) 4892635 47882346 47882313

Konsultan Interior :
Interior Consultant

Konsultan Struktur :
Konsultan Struktur
PT. ADINATA SURYA PRATAMA
ENGINEERING CONSULTANT
Ruko Palazzo Blok P2 NO. 5&7 Bumi Anegrek Jl. Karangasatira, Bekasi
Telp. (021) 92757000, 081389897877
E-mail : adinatas1@gmail.com, pusapriyono@yahoo.com

Konsultan M & E :
M & E Consultant
PT. EMSE
KOMPLEK TAMAN KENCANA BLOK E1 NO.20
LINGKAR LUAR CENGKARENG, JAKARTA 11730

Judul gambar :
Drawing Title
POTONGAN PORTAL - L

Drawn By	Putut	DATE	23/03/14
Job Captain		DATE	
Project Architect		DATE	
Project Manager		DATE	
Project Director		DATE	
OWNER APPROVAL		DATE	

SCALE	1 : 150	
ISSUED FOR	REVISION	DRAWING CODE/NO
CONTRACT.	0	S-02.15
DATE	7/4/14	
FILE :		

LAMPIRAN 2

Model Struktur Perencanaan

TUGAS AKHIR

REDESAIN STRUKTUR GEDUNG
 HOTEL LOMBOK ASTORIA
 MATARAM MENGGUNAKAN PORTAL
 BAJA *CROSS BRACING*

CATATAN

MENGETAHUI / MENYETUJUI

DOSEN PEMBIMBING 1

Dr. Eng. Hariyadi, ST., M.Sc (Eng)
 NIDN: 0027107301

MENGETAHUI / MENYETUJUI

DOSEN PEMBIMBING 2

Nurul Hidayati, ST., M.Eng
 NIDN: 0815049401

DIGAMBAR

Mashul Wathoni
 NIM: 2019D1B081

JUDUL GAMBAR

PROFIL MATERIAL STRUKTUR

SKALA	NO. GAMBAR	JML. GAMBAR
-------	------------	-------------

1 : 10		
--------	--	--

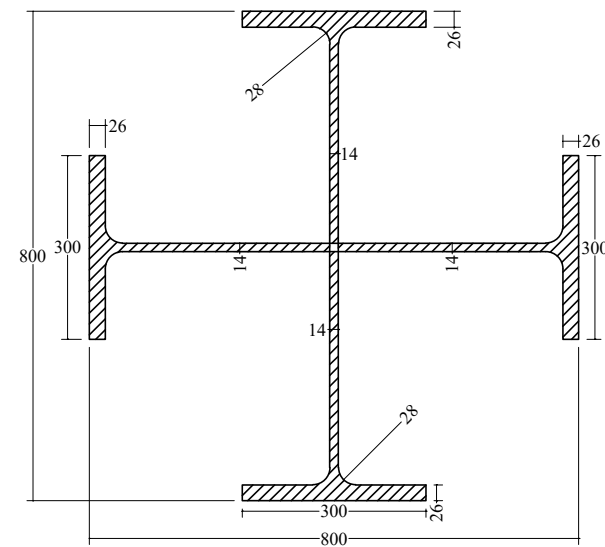

PROFIL KC 1
 SCALA 1:10

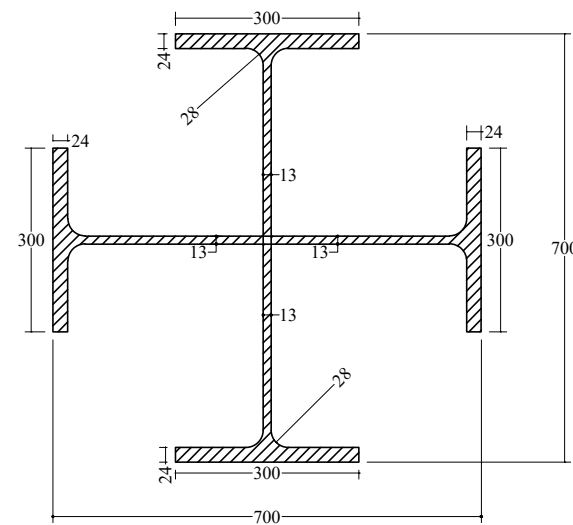

PROFIL KC 2
 SCALA 1:10

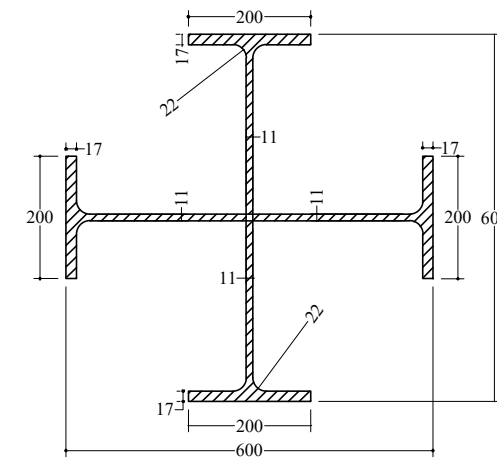

PROFIL KC 3
 SCALA 1:10

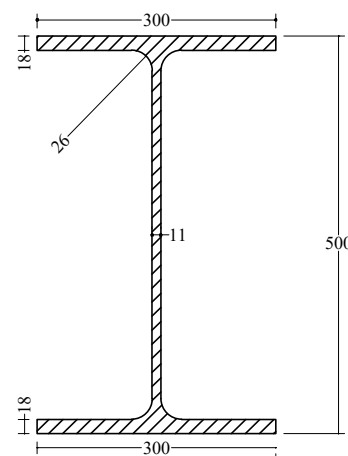

PROFIL BALOK MEMANJANG
 SCALA 1:10

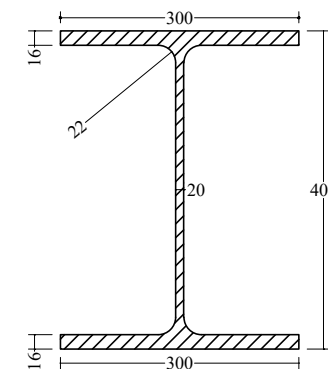

PROFIL BALOK MELINTANG
 SCALA 1:10

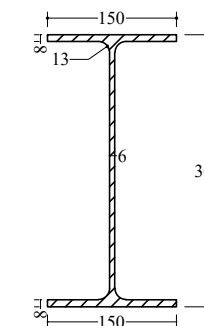

PROFIL *BRACING*
 SCALA 1:10

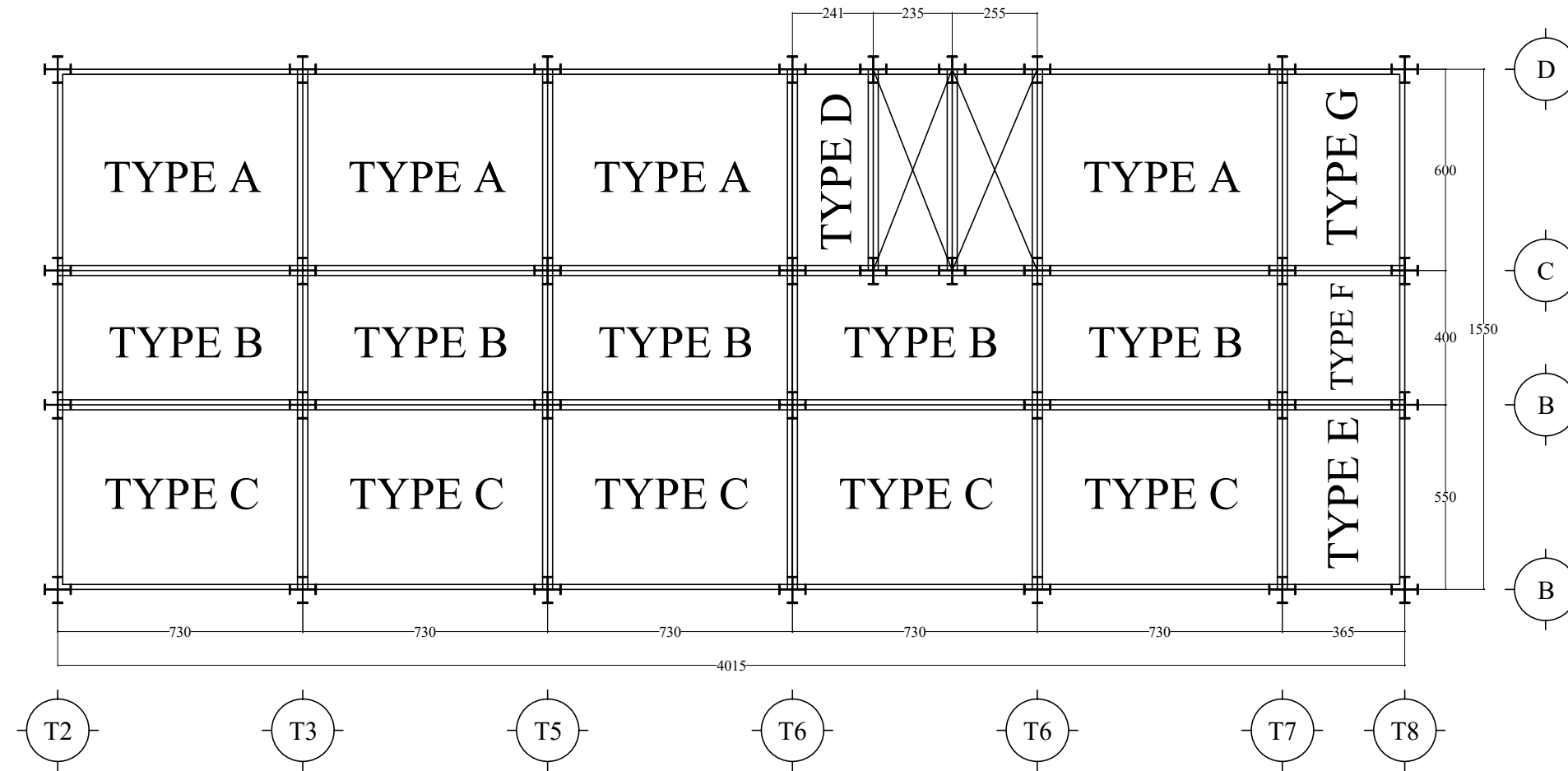

MENGETAHUI / MENYETUJUI

DOSEN PEMBIMBING 1

Dr. Eng. Hariyadi, ST., M.Sc (Eng)
 NIDN: 0027107301

MENGETAHUI / MENYETUJUI

DOSEN PEMBIMBING 2

Nurul Hidayati, ST., M.Eng
 NIDN: 0815049401

DIGAMBAR

Mashul Wathoni
 NIM: 2019D1B081

JUDUL GAMBAR

DENAH TYPE PLAT

SKALA	NO. GAMBAR	JML. GAMBAR
-------	------------	-------------

1 : 100

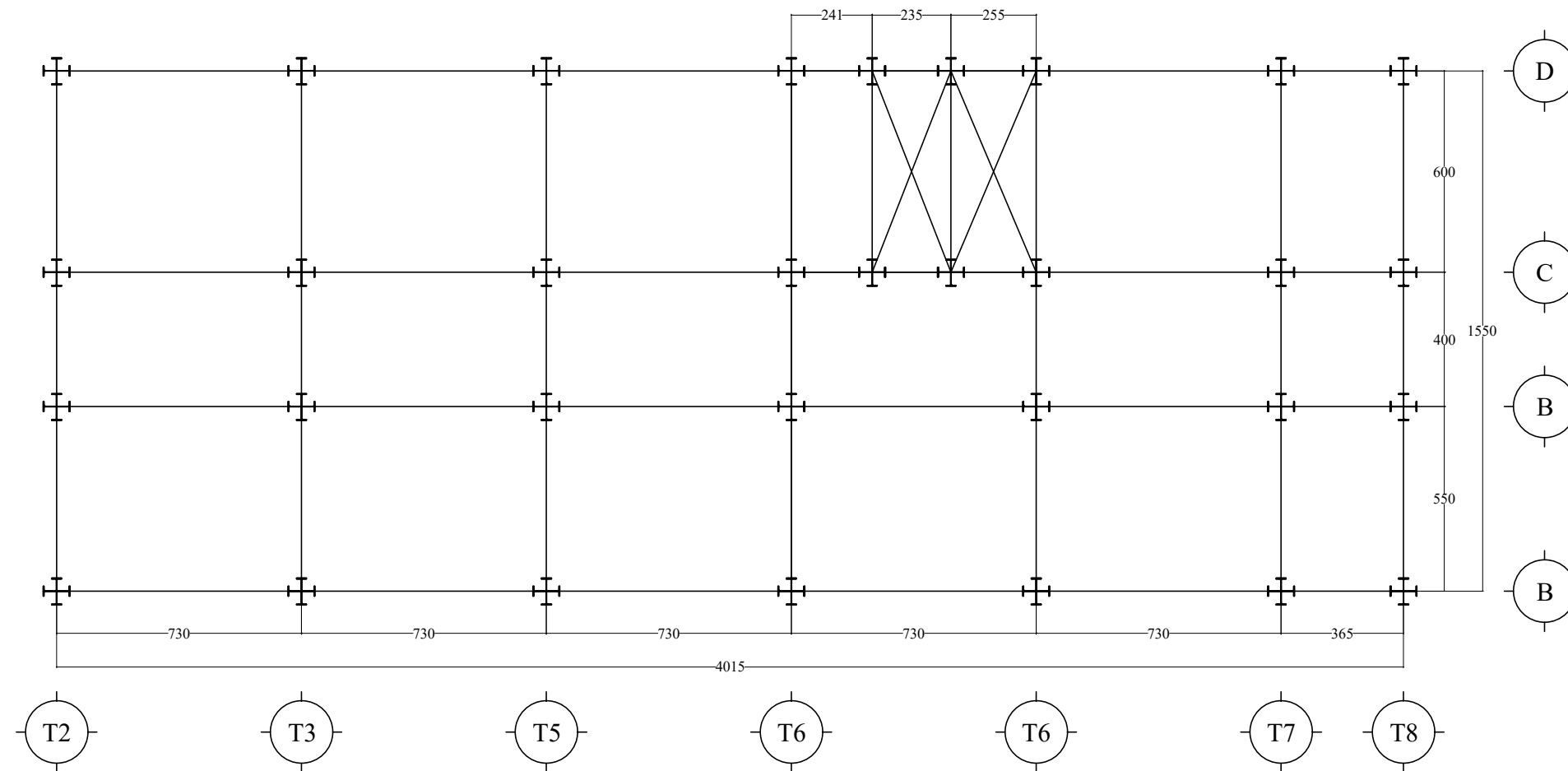

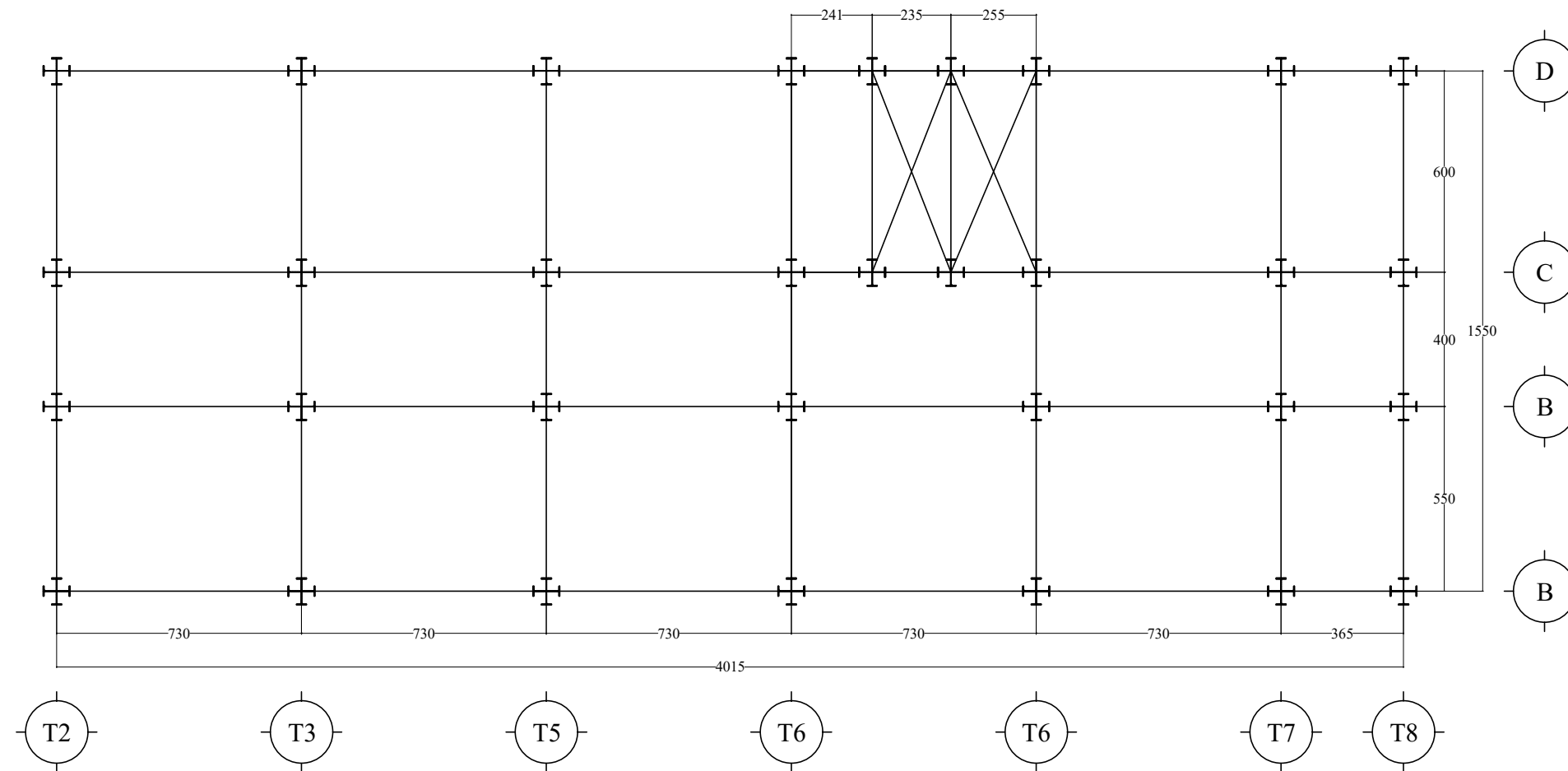

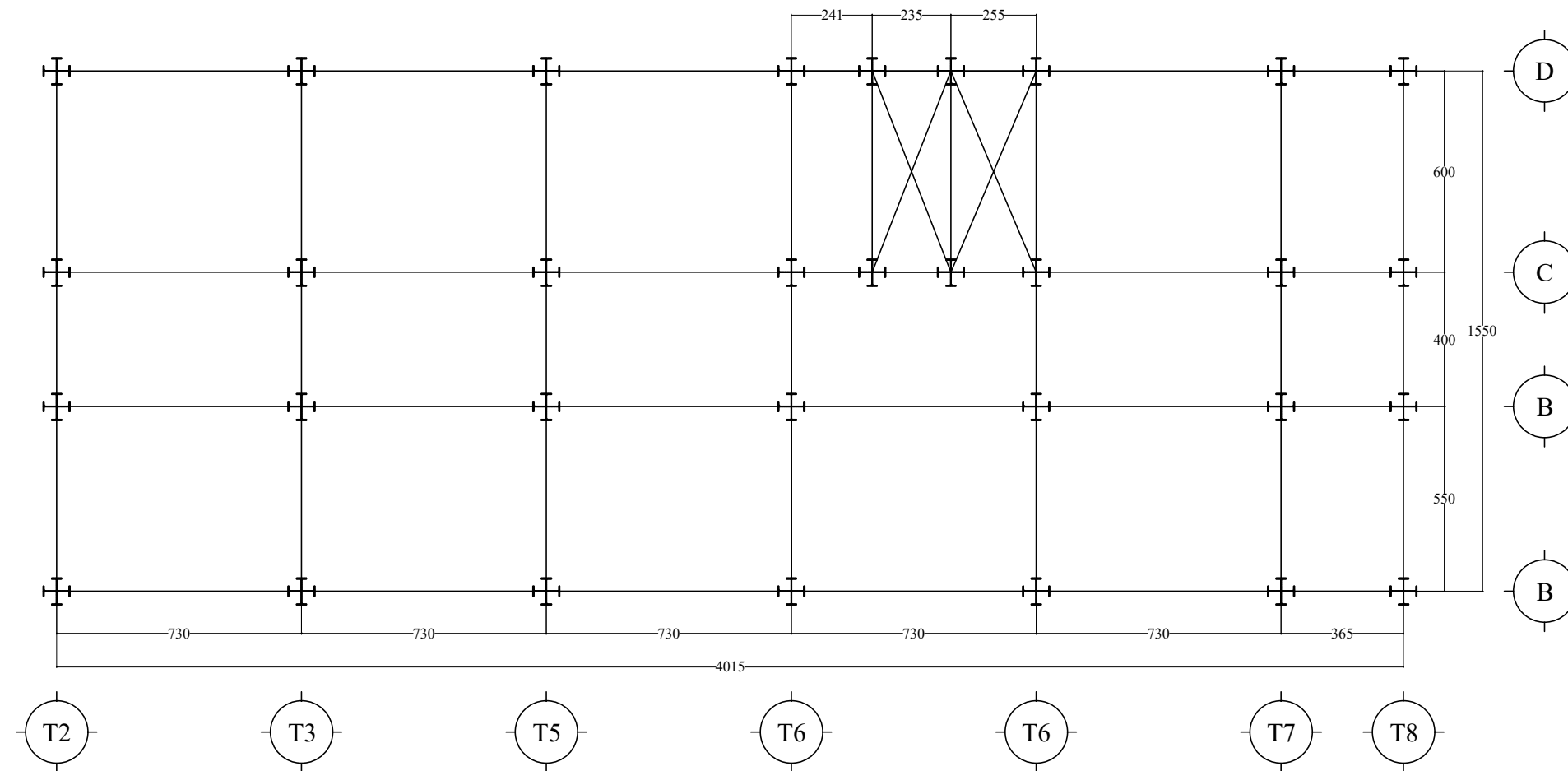

TUGAS AKHIR

REDESAIN STRUKTUR GEDUNG
 HOTEL LOMBOK ASTORIA
 MATARAM MENGGUNAKAN PORTAL
 BAJA *CROSS BRACING*

CATATAN

MENGETAHUI / MENYETUJUI

DOSEN PEMBIMBING 1

Dr. Eng. Hariyadi, ST.,M.Sc (Eng)
 NIDN: 0027107301

MENGETAHUI / MENYETUJUI

DOSEN PEMBIMBING 2

Nurul Hidayati, ST.,M.Eng
 NIDN: 0815049401

DIGAMBAR

Mashul Wathoni
 NIM: 2019D1B081

JUDUL GAMBAR

POTONGAN MEMANJANG STRUKTUR

SKALA	NO. GAMBAR	JML. GAMBAR
-------	------------	-------------

1 : 100		
---------	--	--

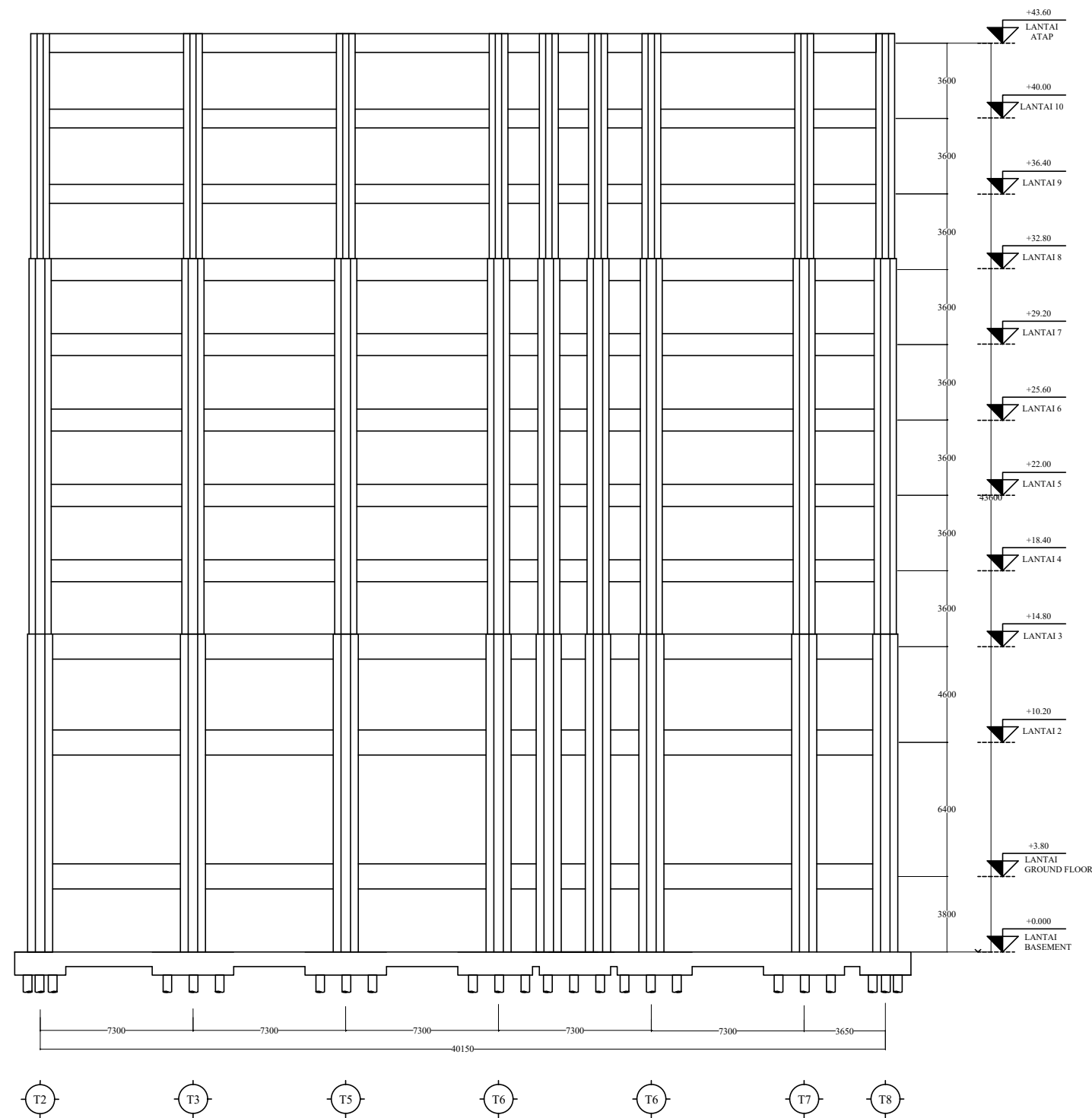

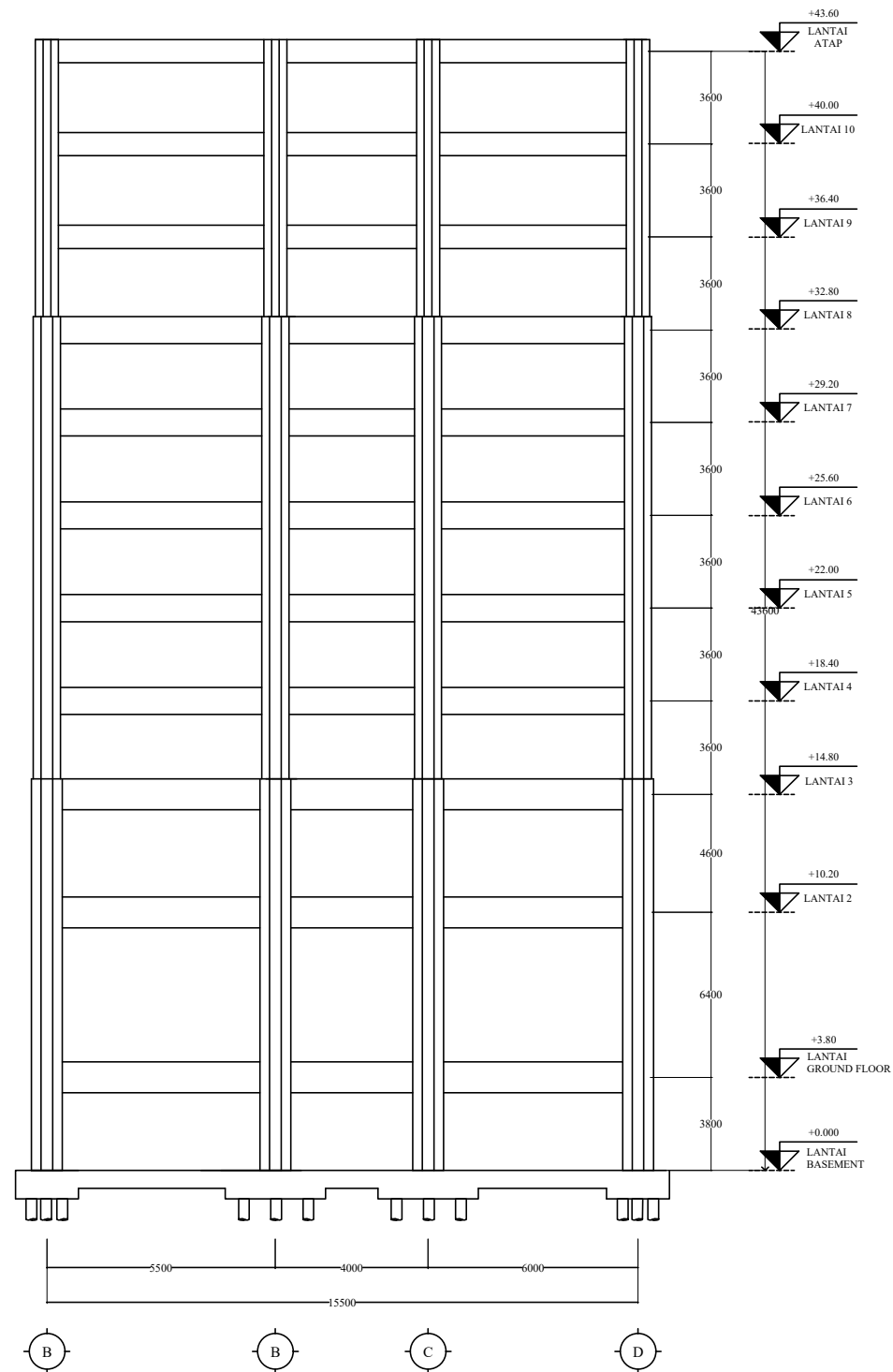

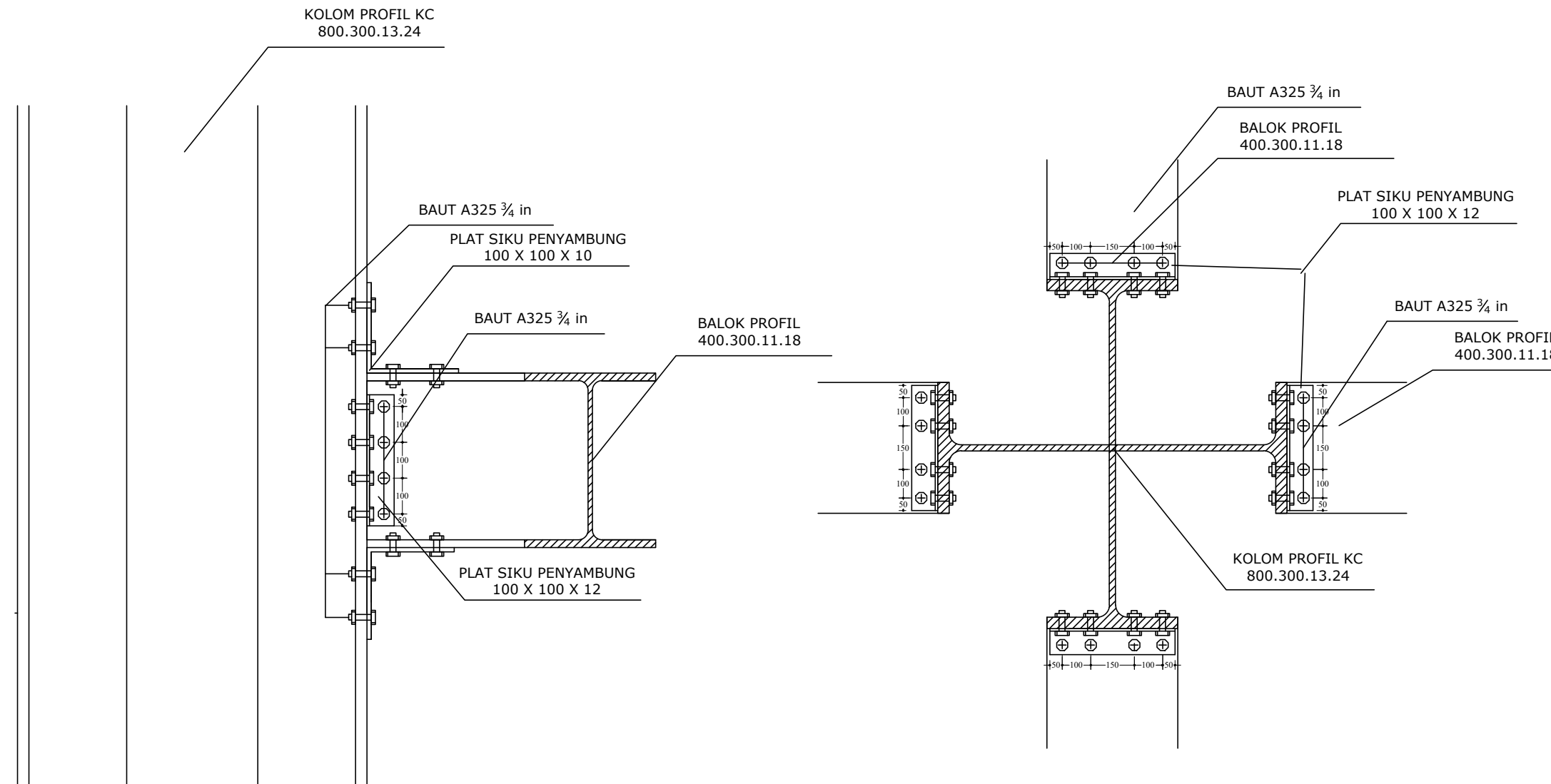

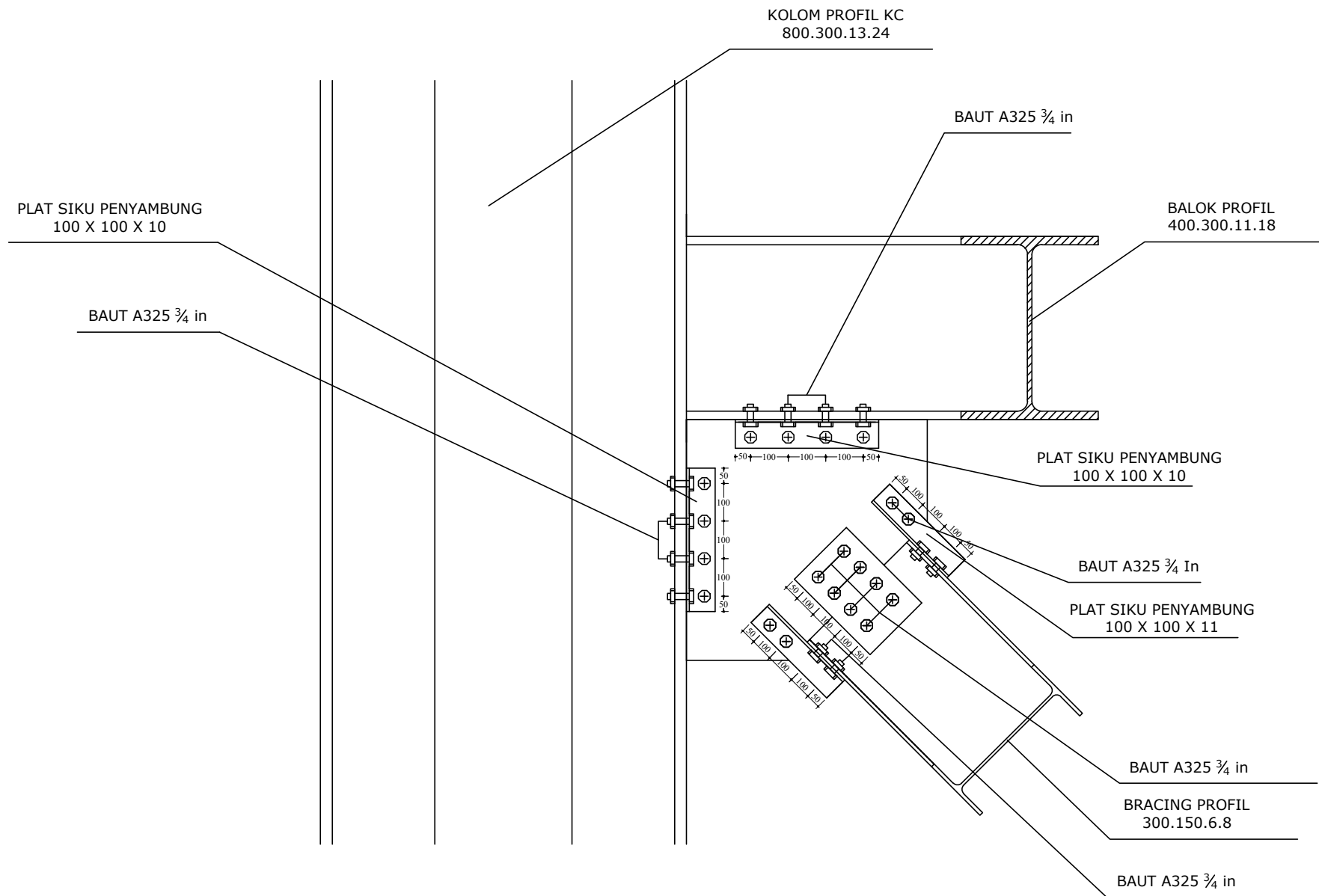

MENGETAHUI / MENYETUJUI

DOSEN PEMBIMBING 1

Dr. Eng. Hariyadi, ST., M.Sc (Eng)
 NIDN: 0027107301

MENGETAHUI / MENYETUJUI

DOSEN PEMBIMBING 2

Nurul Hidayati, ST., M.Eng
 NIDN: 0815049401

DIGAMBAR

Mashul Wathoni
 NIM: 2019D1B081

JUDUL GAMBAR

SAMBUNGAN BRACING - BALOK

SKALA	NO. GAMBAR	JML. GAMBAR
-------	------------	-------------

1 : 10		
--------	--	--

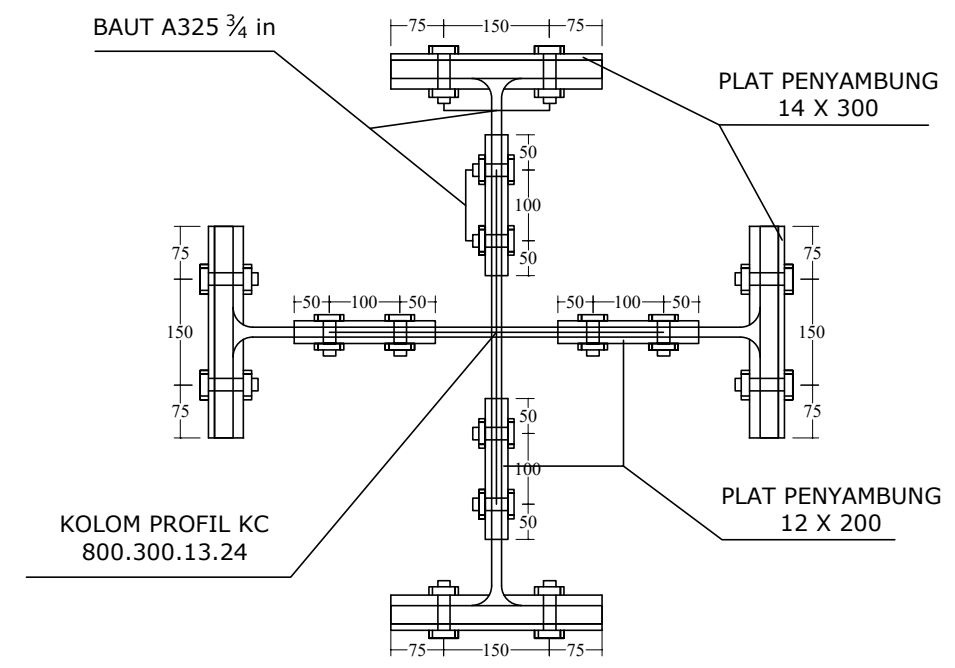
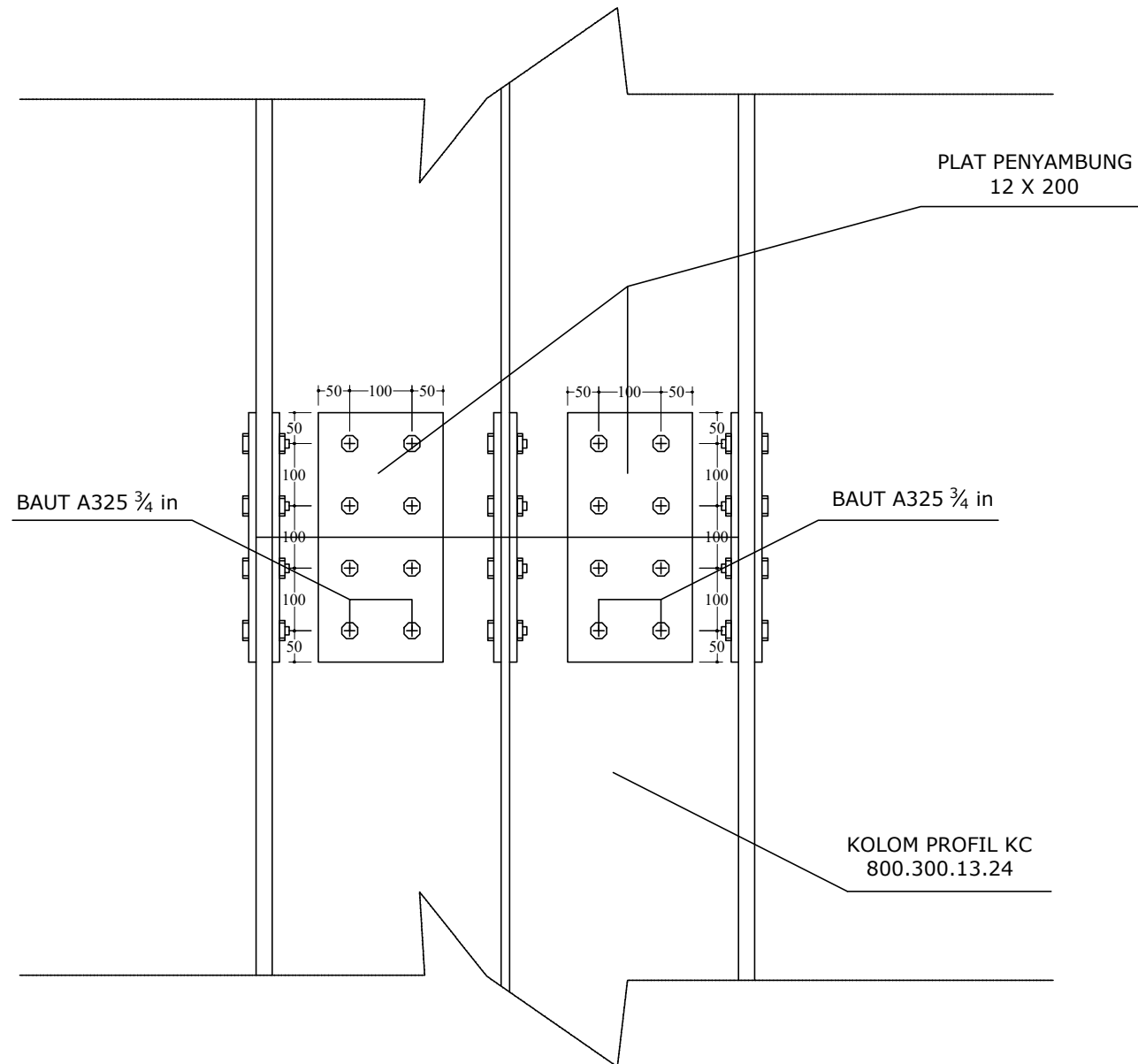

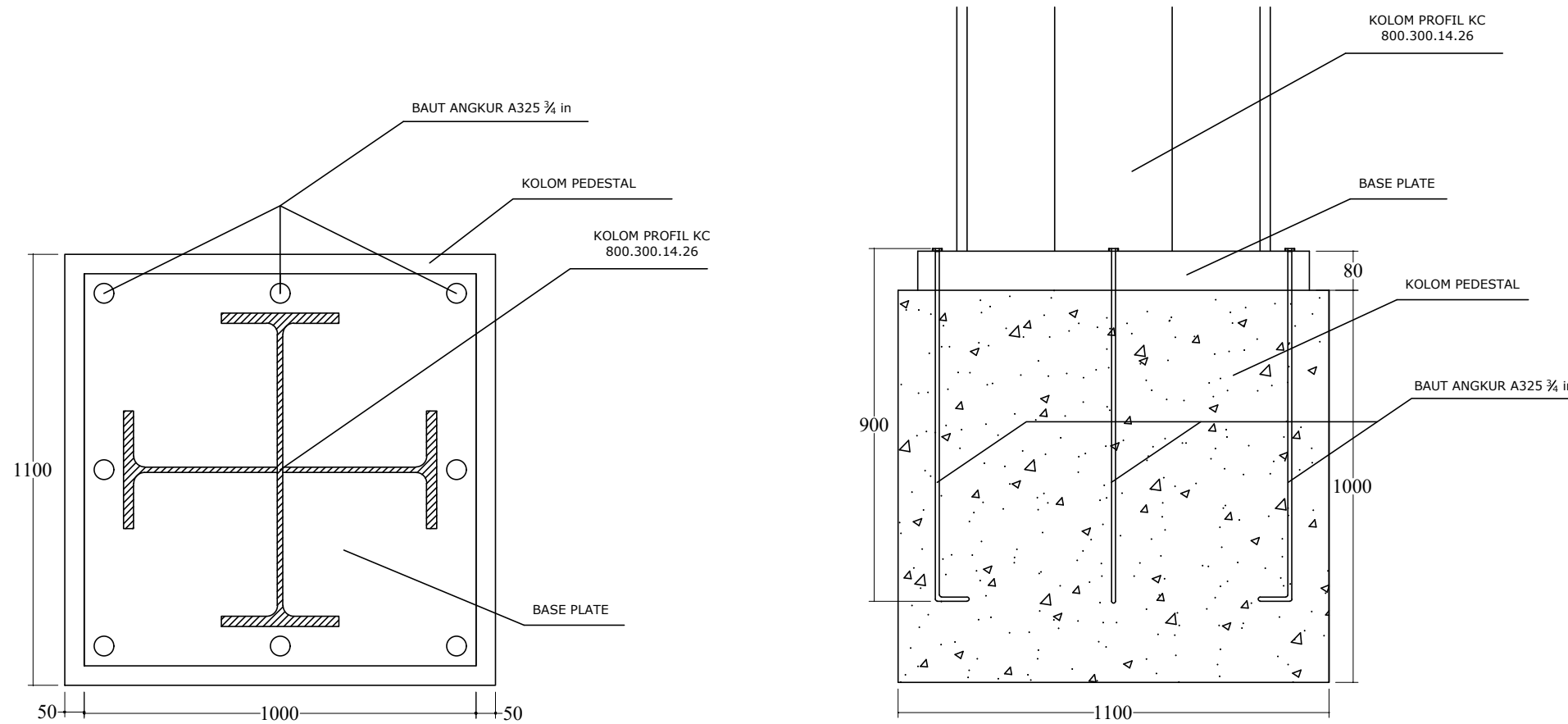

MENGETAHUI / MENYETUJUI

DOSEN PEMBIMBING 1

Dr. Eng. Hariyadi, ST., M.Sc (Eng)
 NIDN: 0027107301

MENGETAHUI / MENYETUJUI

DOSEN PEMBIMBING 2

Nurul Hidayati, ST., M.Eng
 NIDN: 0815049401

DIGAMBAR

Mashul Wathoni
 NIM: 2019D1B081

JUDUL GAMBAR

BASE PLATE

SKALA	NO. GAMBAR	JML. GAMBAR
-------	------------	-------------

1 : 10		
--------	--	--

Dr. Eng. Hariyadi, ST., M.Sc (Eng)
 NIDN: 0027107301

Nurul Hidayati, ST., M.Eng
 NIDN: 0815049401

Mashul Wathoni
 NIM: 2019D1B081

KOLOM PEDESTAL

1 : 10		
--------	--	--

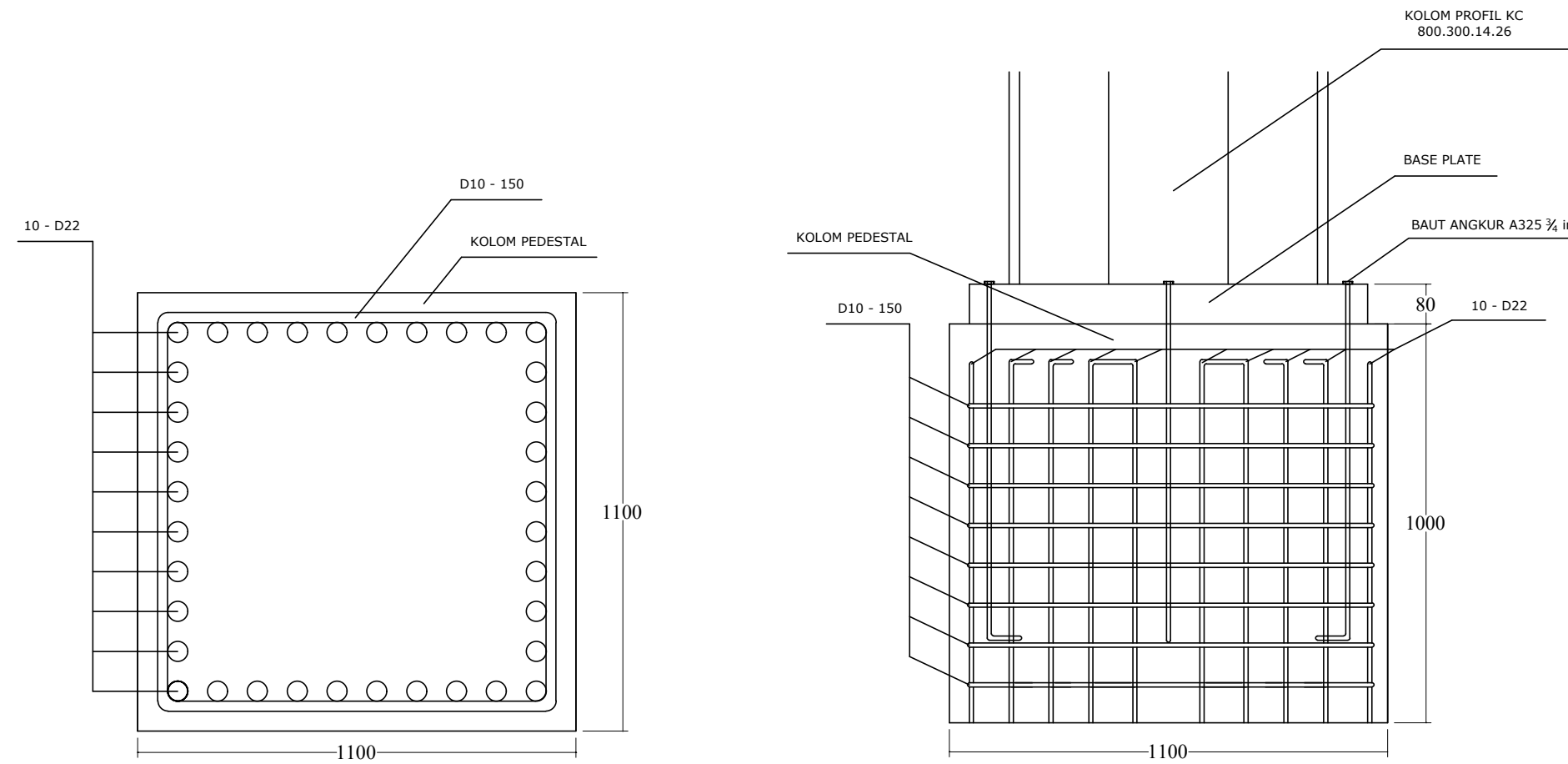

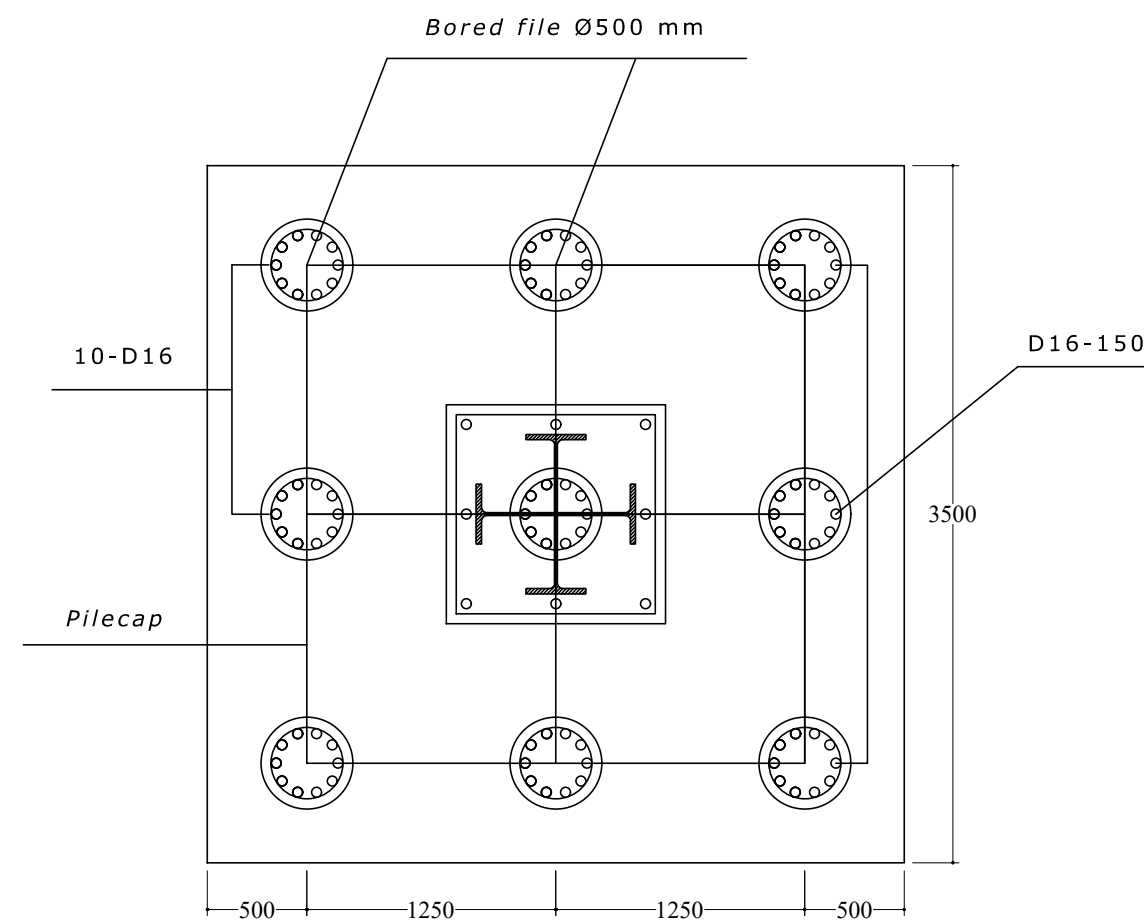

UNIVERSITAS MUHAMMADIYAH MATARAM
FAKULTAS TEKNIK
PROGRAM STUDI TEKNIK SIPIL

TUGAS AKHIR

REDESAIN STRUKTUR GEDUNG
HOTEL LOMBOK ASTORIA
MATARAM MENGGUNAKAN PORTAL
BAJA *CROSS BRACING*

CATATAN

MENGETAHUI / MENYETUJUI

DOSEN PEMBIMBING 1

Dr. Eng. Hariyadi, ST., M.Sc (Eng)
NIDN: 0027107301

MENGETAHUI / MENYETUJUI

DOSEN PEMBIMBING 2

Nurul Hidayati, ST., M.Eng
NIDN: 0815049401

DIGAMBAR

Mashul Wathoni
NIM: 2019D1B081

JUDUL GAMBAR

PONDASI PILECAP

SKALA	NO. GAMBAR	JML. GAMBAR
-------	------------	-------------

1 : 10		
--------	--	--

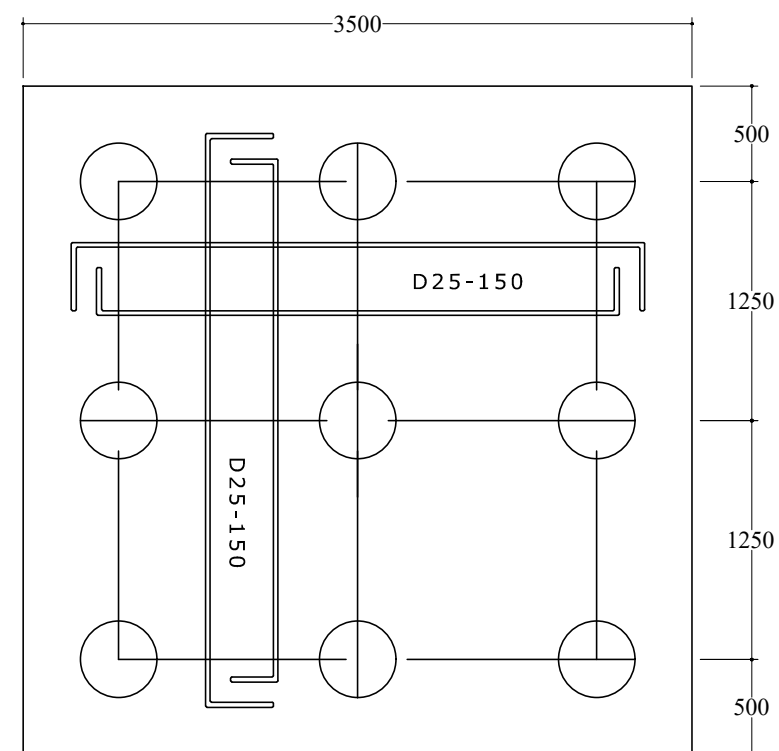

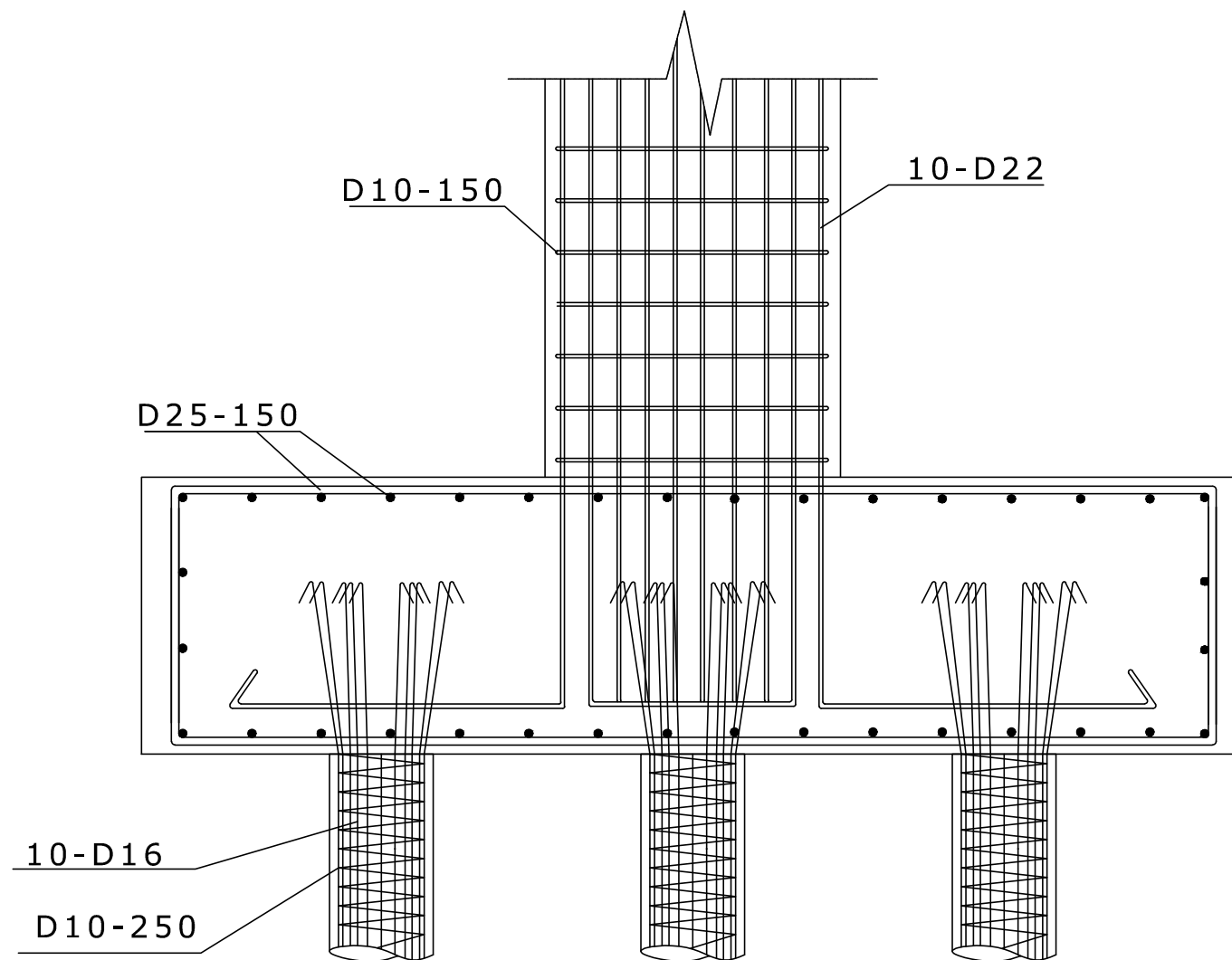

UNIVERSITAS MUHAMMADIYAH MATARAM
 FAKULTAS TEKNIK
 PROGRAM STUDI TEKNIK SIPIL

TUGAS AKHIR

REDESAIN STRUKTUR GEDUNG
 HOTEL LOMBOK ASTORIA
 MATARAM MENGGUNAKAN PORTAL
 BAJA *CROSS BRACING*

CATATAN

MENGETAHUI / MENYETUJUI

DOSEN PEMBIMBING 1

Dr. Eng. Hariyadi, ST., M.Sc (Eng)
 NIDN: 0027107301

MENGETAHUI / MENYETUJUI

DOSEN PEMBIMBING 2

Nurul Hidayati, ST., M.Eng
 NIDN: 0815049401

DIGAMBAR

Mashul Wathoni
 NIM: 2019D1B081

JUDUL GAMBAR

PONDASI BOREFILE

SKALA	NO. GAMBAR	JML. GAMBAR
-------	------------	-------------

1 : 10		
--------	--	--

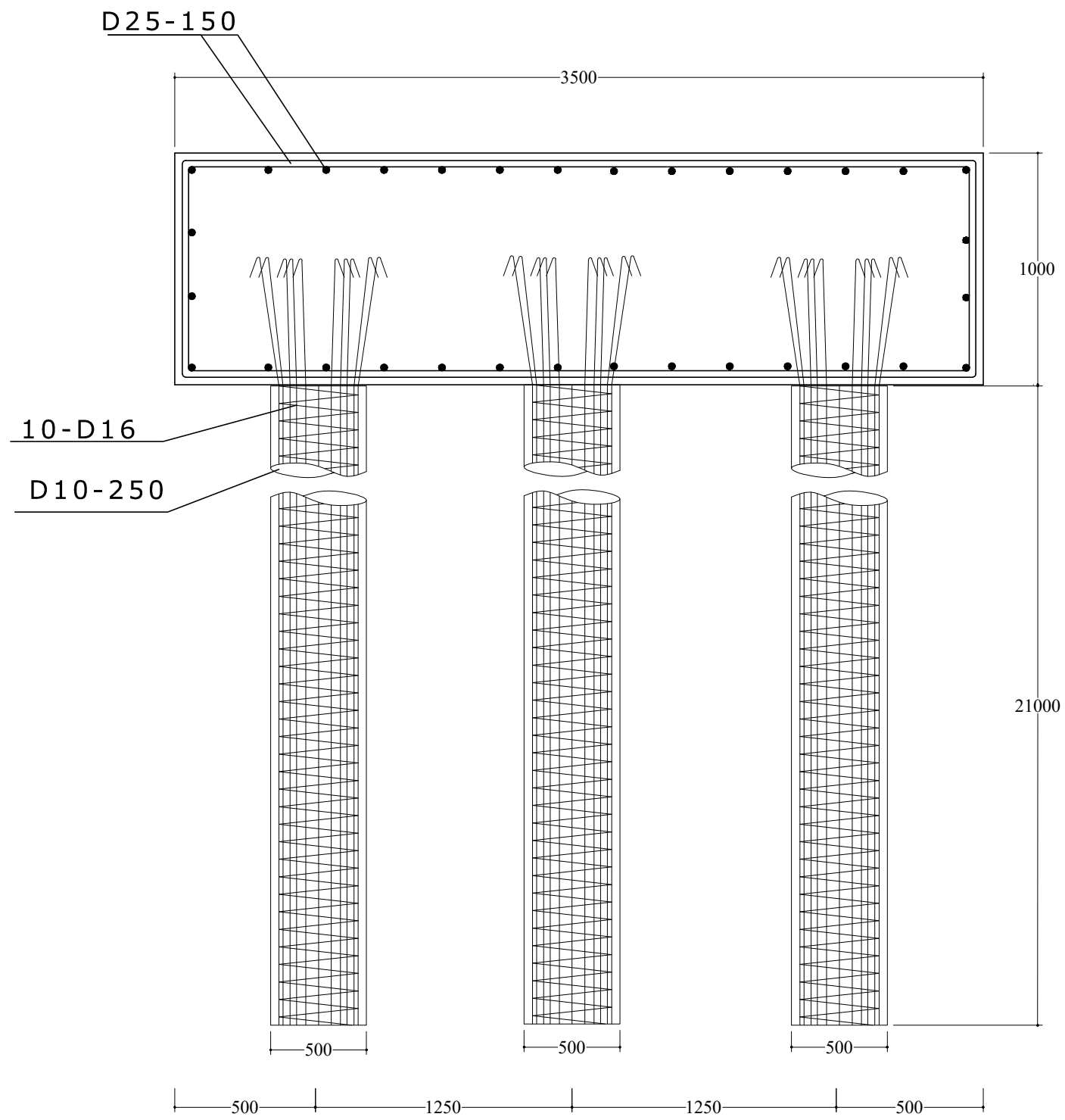

UNIVERSITAS MUHAMMADIYAH MATARAM
FAKULTAS TEKNIK
PROGRAM STUDI TEKNIK SIPIL

TUGAS AKHIR

REDESAIN STRUKTUR GEDUNG
HOTEL LOMBOK ASTORIA
MATARAM MENGGUNAKAN PORTAL
BAJA *CROSS BRACING*

CATATAN

MENGETAHUI / MENYETUJUI

DOSEN PEMBIMBING 1

Dr. Eng. Hariyadi, ST., M.Sc (Eng)
NIDN: 0027107301

MENGETAHUI / MENYETUJUI

DOSEN PEMBIMBING 2

Nurul Hidayati, ST., M.Eng
NIDN: 0815049401

DIGAMBAR

Mashul Wathoni
NIM: 2019D1B081

JUDUL GAMBAR

DETAIL PONDASI

SKALA	NO. GAMBAR	JML. GAMBAR
-------	------------	-------------

1 : 10		
--------	--	--

LAMPIRAN 3

Data Sondir dan Boring

Laporan No.: 292 / LAPORAN / X / 2013

Tgl. pengujian : 21 Oktober 2013

Proyek : PEMBANGUNAN HOTEL LOMBOK

Dikerjakan : Team GEO 2013

Lokasi : Jl. Jenderal Sudirman

: Agung P. ST., MT

Kota Mataram - Nusa Tenggara Barat

No. Titik : S- 01 (Lat 8° 33' 53,2" S, Long 116° 07' 14,5" E)

**UJI PENETRASI KONUS
(ASTM D 3441 - 86)**

Kedalaman	Perlawanan Konus (PK)	Jumlah Perlawanan (JP)	Hambatan Lekat $HL=(JP-PK)/10$	HLx20	JHL	Rasio Gesekan $FR=(HL/PK)$
(METER)	(KG/CM ²)	(KG/CM ²)	(KG/CM ²)	(KG/CM)	(KG/CM)	(%)
0,00	0,00	0,00	0,00	0,00	0,00	0,00
0,20	20,00	30,00	1,00	20,00	20,00	5,00
0,40	40,00	50,00	1,00	20,00	40,00	2,50
0,60	80,00	95,00	1,50	30,00	70,00	1,88
0,80	95,00	105,00	1,00	20,00	90,00	1,05
1,00	90,00	100,00	1,00	20,00	110,00	1,11
1,20	100,00	110,00	1,00	20,00	130,00	1,00
1,40	100,00	110,00	1,00	20,00	150,00	1,00
1,60	115,00	125,00	1,00	20,00	170,00	0,87
1,80	130,00	140,00	1,00	20,00	190,00	0,77
2,00	180,00	185,00	0,50	10,00	200,00	0,28
2,20	170,00	176,00	0,60	12,00	212,00	0,35
2,40	185,00	190,00	0,50	10,00	222,00	0,27
2,60	215,00	220,00	0,50	10,00	232,00	0,23
2,80	250,00	> 250				
3,00						
3,20						
3,40						
3,60						
3,80						
4,00						
4,20						
4,40						
4,60						
4,80						
5,00						
5,20						
5,40						
5,60						
5,80						
6,00						

Laporan No. 292 / LAPORAN / X / 2013

Tgl. pengujian : 21 Oktober 2013

Proyek : PEMBANGUNAN HOTEL LOMBOK

Dikerjakan : Team GEO 2013

Lokasi : Jl. Jenderal Sudirman

Diperiksa

: Agung P. ST., MT

Kota Mataram - Nusa Tenggara Barat

No. Titik : S- 01 (Lat 8° 33' 53,2" S, Long 116° 07' 14,5" E)

**UJI PENETRASI KONUS
(ASTM D 3441 - 86)**

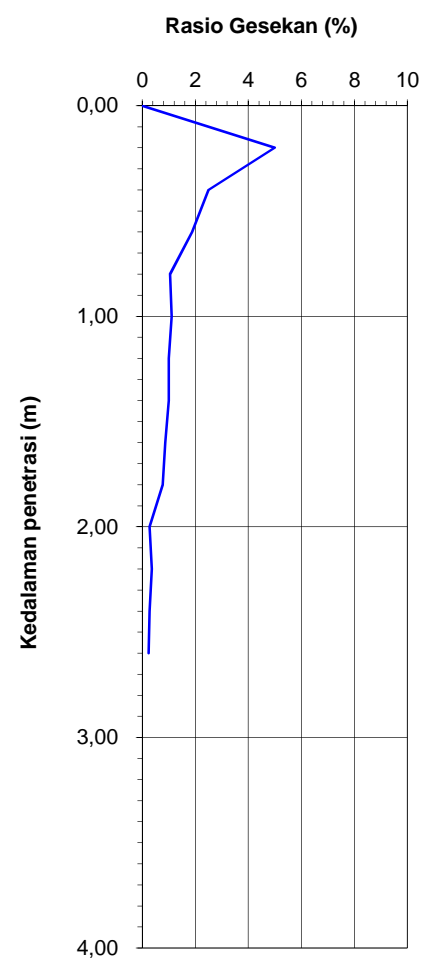
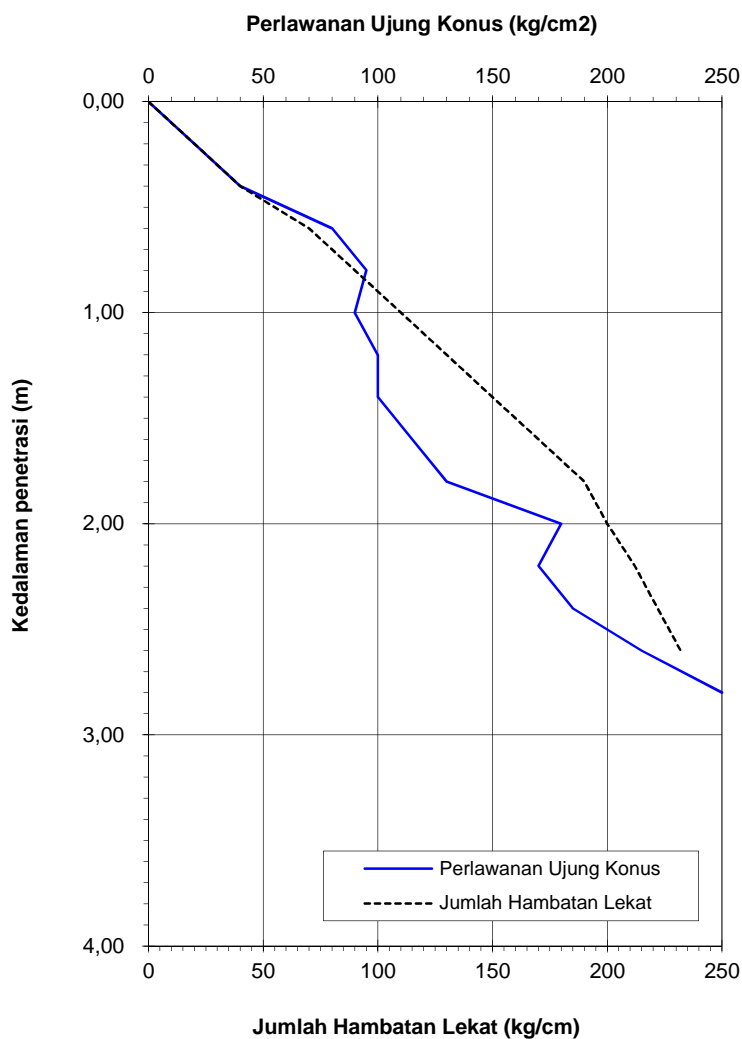

Catatan:

Titik 0 m dari permukaan tanah/ tanah dasar (tempat lokasi sondir)

Pelaksana Soil Test



: MUKA AIR TANAH ditemukan pada kedalaman - 6,00 m (sumur dekat lokasi)

(Agung Prabowo, ST., MT)

()

()

Laporan No.: 292 / LAPORAN / X / 2013

Tgl. pengujian : 21 Oktober 2013

Proyek : PEMBANGUNAN HOTEL LOMBOK

Dikerjakan : Team GEO 2013

Lokasi : Jl. Jenderal Sudirman

: Agung P. ST., MT

Kota Mataram - Nusa Tenggara Barat

No. Titik : S- 02 (Lat 8° 33' 55,0" S, Long 116° 07' 14,1" E)

**UJI PENETRASI KONUS
(ASTM D 3441 - 86)**

Kedalaman	Perlawanan Konus (PK)	Jumlah Perlawanan (JP)	Hambatan Lekat $HL=(JP-PK)/10$	HLx20	JHL	Rasio Gesekan $FR=(HL/PK)$
(METER)	(KG/CM ²)	(KG/CM ²)	(KG/CM ²)	(KG/CM)	(KG/CM)	(%)
0,00	0,00	0,00	0,00	0,00	0,00	0,00
0,20	25,00	30,00	0,50	10,00	10,00	2,00
0,40	50,00	56,00	0,60	12,00	22,00	1,20
0,60	60,00	70,00	1,00	20,00	42,00	1,67
0,80	80,00	85,00	0,50	10,00	52,00	0,63
1,00	75,00	80,00	0,50	10,00	62,00	0,67
1,20	85,00	90,00	0,50	10,00	72,00	0,59
1,40	80,00	85,00	0,50	10,00	82,00	0,63
1,60	105,00	115,00	1,00	20,00	102,00	0,95
1,80	100,00	105,00	0,50	10,00	112,00	0,50
2,00	115,00	120,00	0,50	10,00	122,00	0,43
2,20	145,00	150,00	0,50	10,00	132,00	0,34
2,40	185,00	190,00	0,50	10,00	142,00	0,27
2,60	210,00	215,00	0,50	10,00	152,00	0,24
2,80	250,00	> 250				
3,00						
3,20						
3,40						
3,60						
3,80						
4,00						
4,20						
4,40						
4,60						
4,80						
5,00						
5,20						
5,40						
5,60						
5,80						
6,00						

Laporan No. **292 / LAPORAN / X / 2013**

Tgl. pengujian : **21 Oktober 2013**

Proyek : **PEMBANGUNAN HOTEL LOMBOK**

Dikerjakan : **Team GEO 2013**

Lokasi : **Jl. Jenderal Sudirman**

Diperiksa : **Agung P. ST., MT**

Kota Mataram - Nusa Tenggara Barat

No. Titik : **S- 02 (Lat 8° 33' 55,0" S, Long 116° 07' 14,1" E)**

**UJI PENETRASI KONUS
(ASTM D 3441 - 86)**

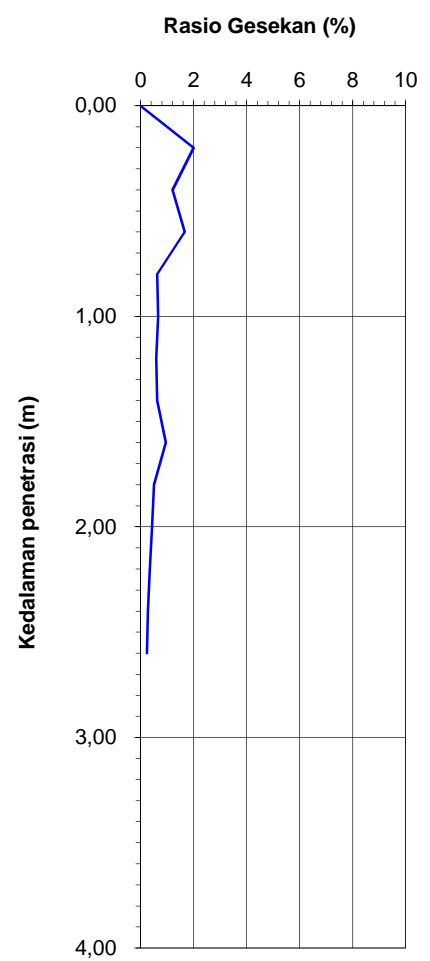
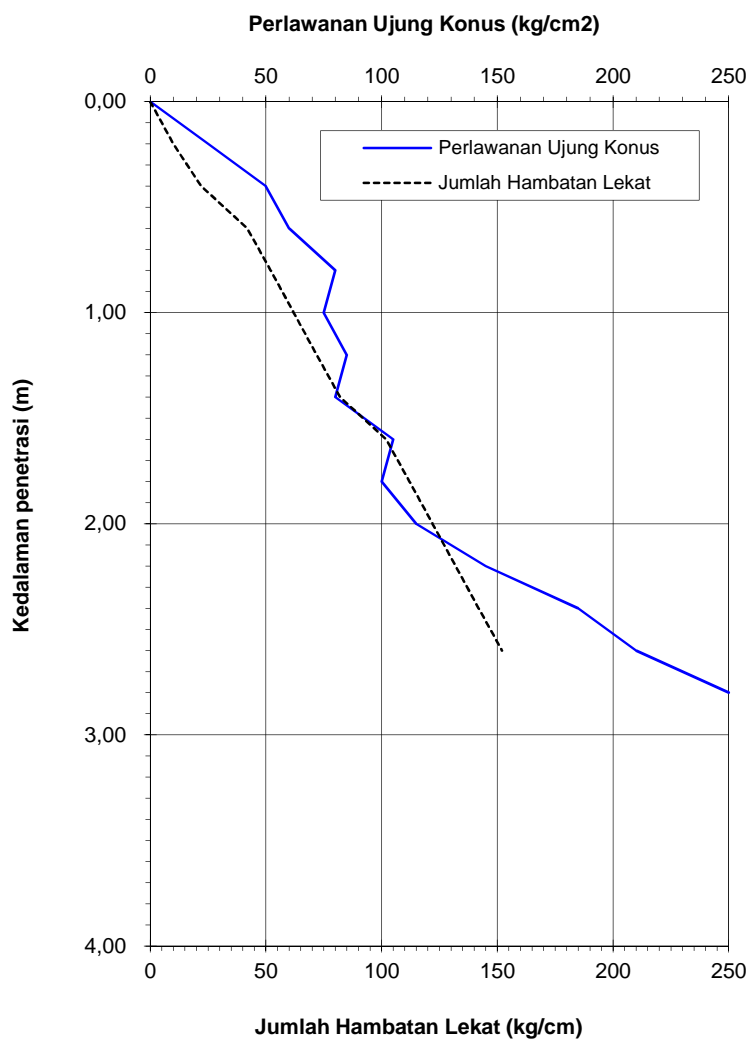

Catatan:

Titik 0 m dari permukaan tanah/ tanah dasar (tempat lokasi sondir)

Pelaksana Soil Test



: MUKA AIR TANAH ditemukan pada kedalaman - 6,00 m (sumur dekat lokasi)

(Agung Prabowo, ST., MT)

()

()

Laporan No.: 292 / LAPORAN / X / 2013

Tgl. pengujian : 21 Oktober 2013

Proyek : PEMBANGUNAN HOTEL LOMBOK

Dikerjakan : Team GEO 2013

Lokasi : Jl. Jenderal Sudirman

: Agung P. ST., MT

Kota Mataram - Nusa Tenggara Barat

No. Titik : S- 03 (Lat 8° 33' 57,2" S, Long 116° 07' 13,7" E)

**UJI PENETRASI KONUS
(ASTM D 3441 - 86)**

Kedalaman	Perlawanan Konus (PK)	Jumlah Perlawanan (JP)	Hambatan Lekat $HL=(JP-PK)/10$	HLx20	JHL	Rasio Gesekan $FR=(HL/PK)$
(METER)	(KG/CM ²)	(KG/CM ²)	(KG/CM ²)	(KG/CM)	(KG/CM)	(%)
0,00	0,00	0,00	0,00	0,00	0,00	0,00
0,20	45,00	55,00	1,00	20,00	20,00	2,22
0,40	90,00	98,00	0,80	16,00	36,00	0,89
0,60	80,00	85,00	0,50	10,00	46,00	0,63
0,80	80,00	90,00	1,00	20,00	66,00	1,25
1,00	40,00	50,00	1,00	20,00	86,00	2,50
1,20	50,00	55,00	0,50	10,00	96,00	1,00
1,40	50,00	60,00	1,00	20,00	116,00	2,00
1,60	55,00	60,00	0,50	10,00	126,00	0,91
1,80	80,00	85,00	0,50	10,00	136,00	0,63
2,00	90,00	100,00	1,00	20,00	156,00	1,11
2,20	105,00	120,00	1,50	30,00	186,00	1,43
2,40	150,00	155,00	0,50	10,00	196,00	0,33
2,60	140,00	145,00	0,50	10,00	206,00	0,36
2,80	180,00	185,00	0,50	10,00	216,00	0,28
3,00	200,00	205,00	0,50	10,00	226,00	0,25
3,20	250,00	> 250				
3,40						
3,60						
3,80						
4,00						
4,20						
4,40						
4,60						
4,80						
5,00						
5,20						
5,40						
5,60						
5,80						
6,00						



Laporan No. 292 / LAPORAN / X / 2013

Tgl. pengujian : 21 Oktober 2013

Proyek : PEMBANGUNAN HOTEL LOMBOK

Dikerjakan : Team GEO 2013

Lokasi : Jl. Jenderal Sudirman

Diperiksa : Agung P. ST., MT

Kota Mataram - Nusa Tenggara Barat

No. Titik : S- 03 (Lat 8° 33' 57,2" S, Long 116° 07' 13,7" E)

UJI PENETRASI KONUS
(ASTM D 3441 - 86)

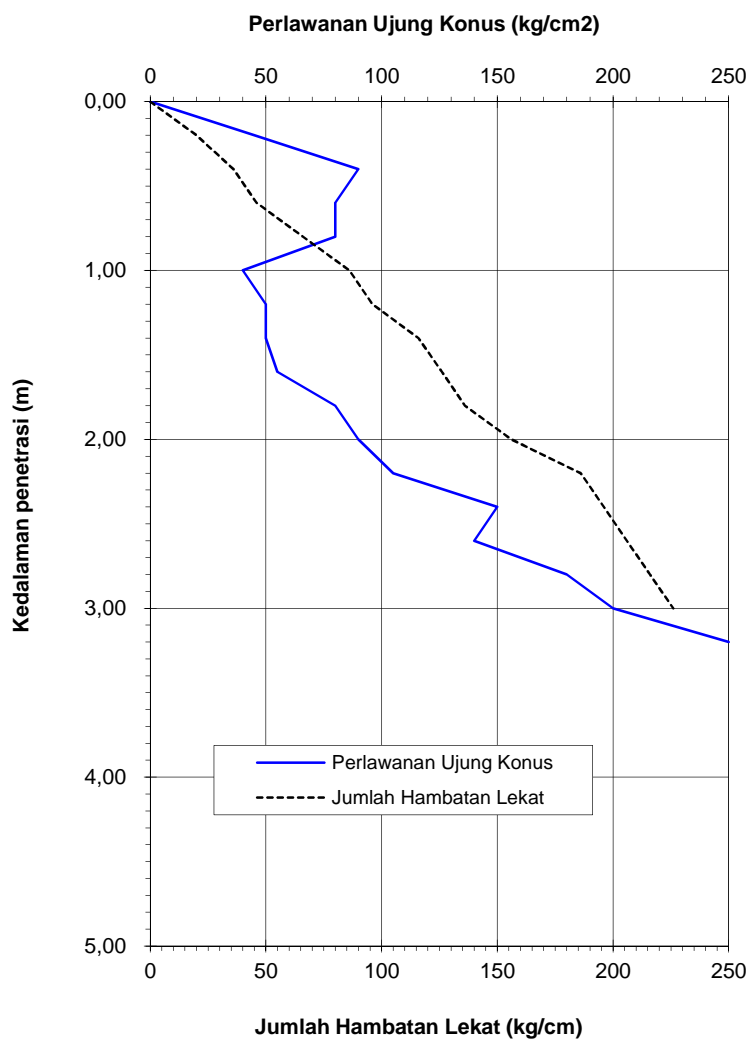

Catatan:

Titik 0 m dari permukaan tanah/ tanah dasar (tempat lokasi sondir)

Pelaksana Soil Test



: MUKA AIR TANAH ditemukan pada kedalaman - 6,00 m (sumur dekat lokasi)

(Agung Prabowo, ST., MT)

()

()

Laporan No.: 292 / LAPORAN / X / 2013

Tgl. pengujian : 21 Oktober 2013

Proyek : PEMBANGUNAN HOTEL LOMBOK

Dikerjakan : Team GEO 2013

Lokasi : Jl. Jenderal Sudirman

: Agung P. ST., MT

Kota Mataram - Nusa Tenggara Barat

No. Titik : S- 04 (Lat 8° 33' 57,3" S, Long 116° 07' 14,6" E)

**UJI PENETRASI KONUS
(ASTM D 3441 - 86)**

Kedalaman	Perlawanan Konus (PK)	Jumlah Perlawanan (JP)	Hambatan Lekat HL=(JP-PK)/10	HLx20	JHL	Rasio Gesekan FR=(HL/PK)
(METER)	(KG/CM ²)	(KG/CM ²)	(KG/CM ²)	(KG/CM)	(KG/CM)	(%)
0,00	0,00	0,00	0,00	0,00	0,00	0,00
0,20	15,00	25,00	1,00	20,00	20,00	6,67
0,40	30,00	40,00	1,00	20,00	40,00	3,33
0,60	40,00	50,00	1,00	20,00	60,00	2,50
0,80	40,00	50,00	1,00	20,00	80,00	2,50
1,00	65,00	70,00	0,50	10,00	90,00	0,77
1,20	65,00	70,00	0,50	10,00	100,00	0,77
1,40	85,00	90,00	0,50	10,00	110,00	0,59
1,60	100,00	110,00	1,00	20,00	130,00	1,00
1,80	125,00	130,00	0,50	10,00	140,00	0,40
2,00	150,00	160,00	1,00	20,00	160,00	0,67
2,20	150,00	156,00	0,60	12,00	172,00	0,40
2,40	150,00	155,00	0,50	10,00	182,00	0,33
2,60	210,00	215,00	0,50	10,00	192,00	0,24
2,80	250,00	> 250				
3,00						
3,20						
3,40						
3,60						
3,80						
4,00						
4,20						
4,40						
4,60						
4,80						
5,00						
5,20						
5,40						
5,60						
5,80						
6,00						

Laporan No. **292 / LAPORAN / X / 2013**

Tgl. pengujian : **21 Oktober 2013**

Proyek : **PEMBANGUNAN HOTEL LOMBOK**

Dikerjakan : **Team GEO 2013**

Lokasi : **Jl. Jenderal Sudirman**

Diperiksa : **Agung P. ST., MT**

Kota Mataram - Nusa Tenggara Barat

No. Titik : **S- 04 (Lat 8° 33' 57,3" S, Long 116° 07' 14,6" E)**

**UJI PENETRASI KONUS
(ASTM D 3441 - 86)**

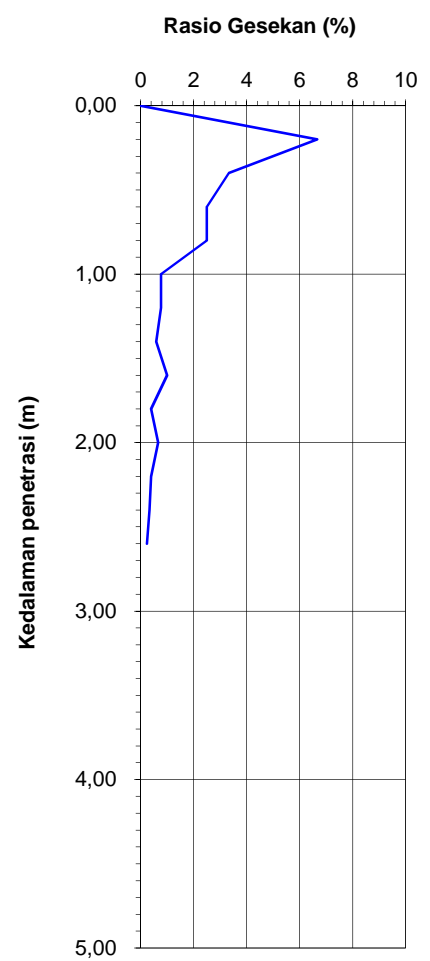
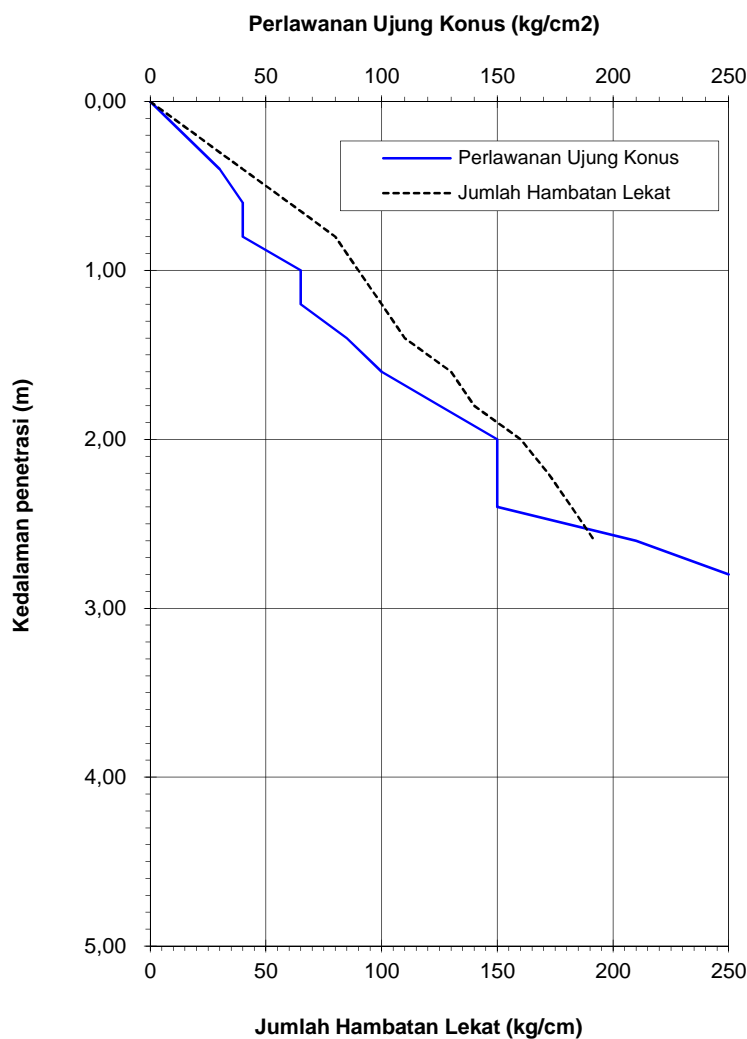

Catatan:

Titik 0 m dari permukaan tanah/ tanah dasar (tempat lokasi sondir)

Pelaksana Soil Test



: MUKA AIR TANAH ditemukan pada kedalaman - 6,00 m (sumur dekat lokasi)

(Agung Prabowo, ST., MT)

()

()

Laporan No.: 292 / LAPORAN / X / 2013

Tgl. pengujian : 21 Oktober 2013

Proyek : PEMBANGUNAN HOTEL LOMBOK

Dikerjakan : Team GEO 2013

Lokasi : Jl. Jenderal Sudirman

: Agung P. ST., MT

Kota Mataram - Nusa Tenggara Barat

No. Titik : S- 05 (Lat 8° 33' 55,4" S, Long 116° 07' 15,2" E)

**UJI PENETRASI KONUS
(ASTM D 3441 - 86)**

Kedalaman	Perlawanan Konus (PK)	Jumlah Perlawanan (JP)	Hambatan Lekat HL=(JP-PK)/10	HLx20	JHL	Rasio Gesekan FR=(HL/PK)
(METER)	(KG/CM ²)	(KG/CM ²)	(KG/CM ²)	(KG/CM)	(KG/CM)	(%)
0,00	0,00	0,00	0,00	0,00	0,00	0,00
0,20	25,00	35,00	1,00	20,00	20,00	4,00
0,40	50,00	60,00	1,00	20,00	40,00	2,00
0,60	40,00	50,00	1,00	20,00	60,00	2,50
0,80	40,00	44,00	0,40	8,00	68,00	1,00
1,00	25,00	30,00	0,50	10,00	78,00	2,00
1,20	60,00	70,00	1,00	20,00	98,00	1,67
1,40	105,00	110,00	0,50	10,00	108,00	0,48
1,60	80,00	86,00	0,60	12,00	120,00	0,75
1,80	100,00	105,00	0,50	10,00	130,00	0,50
2,00	130,00	140,00	1,00	20,00	150,00	0,77
2,20	160,00	165,00	0,50	10,00	160,00	0,31
2,40	180,00	190,00	1,00	20,00	180,00	0,56
2,60	230,00	240,00	1,00	20,00	200,00	0,43
2,80	250,00	> 250				
3,00						
3,20						
3,40						
3,60						
3,80						
4,00						
4,20						
4,40						
4,60						
4,80						
5,00						
5,20						
5,40						
5,60						
5,80						
6,00						



Laporan No. 292 / LAPORAN / X / 2013

Tgl. pengujian : 21 Oktober 2013

Proyek : PEMBANGUNAN HOTEL LOMBOK

Dikerjakan : Team GEO 2013

Lokasi : Jl. Jenderal Sudirman

Diperiksa : Agung P. ST., MT

Kota Mataram - Nusa Tenggara Barat

No. Titik : S- 05 (Lat 8° 33' 55,4" S, Long 116° 07' 15,2" E)

UJI PENETRASI KONUS
(ASTM D 3441 - 86)

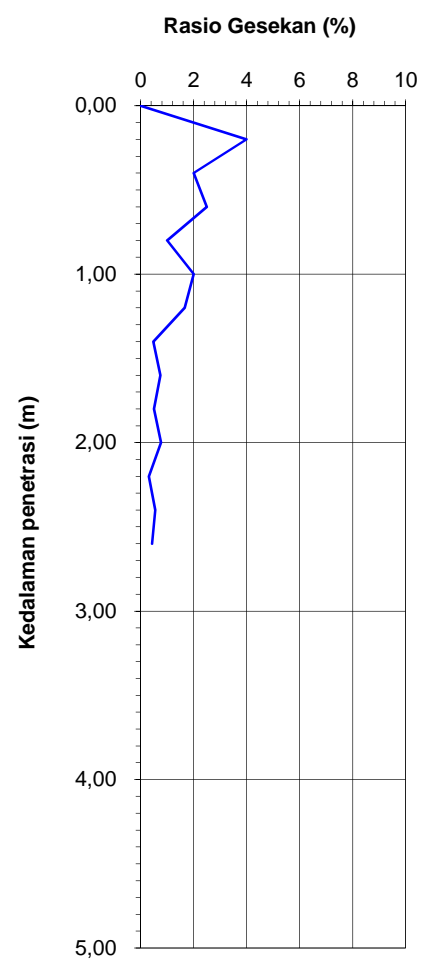
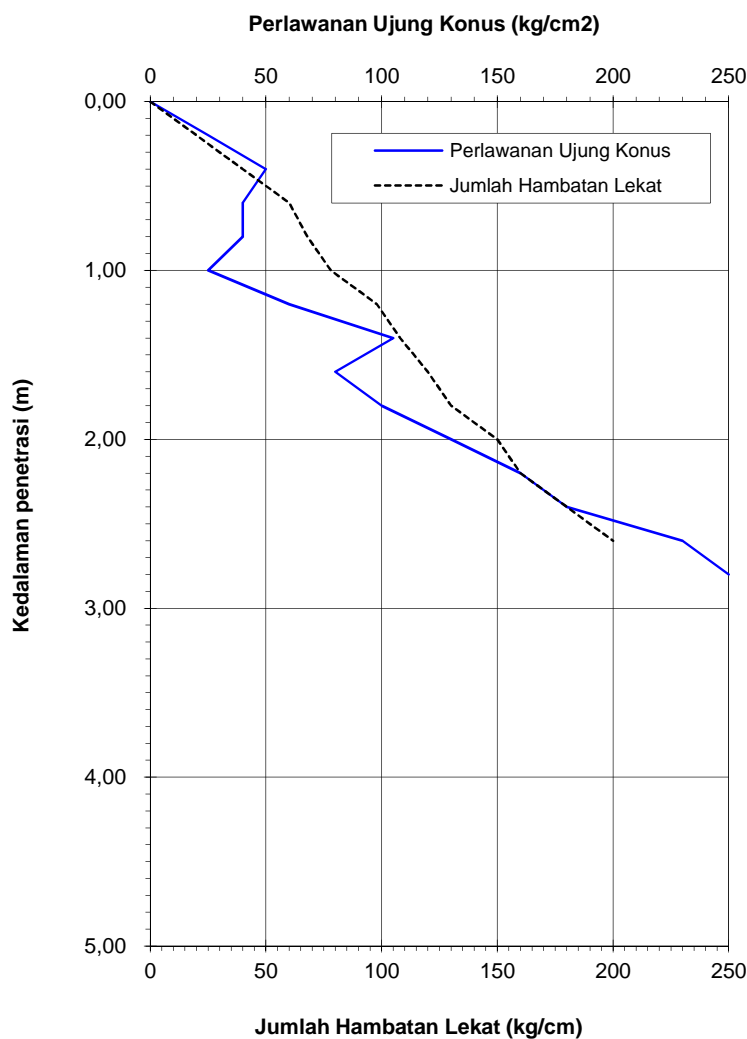

Catatan:

Titik 0 m dari permukaan tanah/ tanah dasar (tempat lokasi sondir)

Pelaksana Soil Test



: MUKA AIR TANAH ditemukan pada kedalaman - 6,00 m (sumur dekat lokasi)

(Agung Prabowo, ST., MT)

()

()

Laporan No.: **292 / LAPORAN / X / 2013**

 Tgl. pengujian : **21 Oktober 2013**

 Proyek : **PEMBANGUNAN HOTEL LOMBOK**

 Dikerjakan : **Team GEO 2013**

 Lokasi : **Jl. Jenderal Sudirman**

 : **Agung P. ST., MT**
Kota Mataram - Nusa Tenggara Barat

 No. Titik : **S- 06 (Lat 8° 33' 53,4" S, Long 116° 07' 15,7" E)**
**UJI PENETRASI KONUS
 (ASTM D 3441 - 86)**

Kedalaman	Perlawanan Konus (PK)	Jumlah Perlawanan (JP)	Hambatan Lekat HL=(JP-PK)/10	HLx20	JHL	Rasio Gesekan FR=(HL/PK)
(METER)	(KG/CM ²)	(KG/CM ²)	(KG/CM ²)	(KG/CM)	(KG/CM)	(%)
0,00	0,00	0,00	0,00	0,00	0,00	0,00
0,20	25,00	30,00	0,50	10,00	10,00	2,00
0,40	55,00	60,00	0,50	10,00	20,00	0,91
0,60	30,00	35,00	0,50	10,00	30,00	1,67
0,80	30,00	37,00	0,70	14,00	44,00	2,33
1,00	40,00	50,00	1,00	20,00	64,00	2,50
1,20	90,00	100,00	1,00	20,00	84,00	1,11
1,40	80,00	85,00	0,50	10,00	94,00	0,63
1,60	100,00	105,00	0,50	10,00	104,00	0,50
1,80	125,00	130,00	0,50	10,00	114,00	0,40
2,00	145,00	150,00	0,50	10,00	124,00	0,34
2,20	130,00	135,00	0,50	10,00	134,00	0,38
2,40	105,00	110,00	0,50	10,00	144,00	0,48
2,60	115,00	120,00	0,50	10,00	154,00	0,43
2,80	115,00	120,00	0,50	10,00	164,00	0,43
3,00	120,00	125,00	0,50	10,00	174,00	0,42
3,20	125,00	130,00	0,50	10,00	184,00	0,40
3,40	130,00	140,00	1,00	20,00	204,00	0,77
3,60	160,00	165,00	0,50	10,00	214,00	0,31
3,80	175,00	180,00	0,50	10,00	224,00	0,29
4,00	220,00	225,00	0,50	10,00	234,00	0,23
4,20	250,00	> 250				
4,40						
4,60						
4,80						
5,00						
5,20						
5,40						
5,60						
5,80						
6,00						



Laporan No. 292 / LAPORAN / X / 2013

Tgl. pengujian : 21 Oktober 2013

Proyek : PEMBANGUNAN HOTEL LOMBOK

Dikerjakan : Team GEO 2013

Lokasi : Jl. Jenderal Sudirman

Diperiksa : Agung P. ST., MT

Kota Mataram - Nusa Tenggara Barat

No. Titik : S- 06 (Lat 8° 33' 53,4" S, Long 116° 07' 15,7" E)

**UJI PENETRASI KONUS
(ASTM D 3441 - 86)**

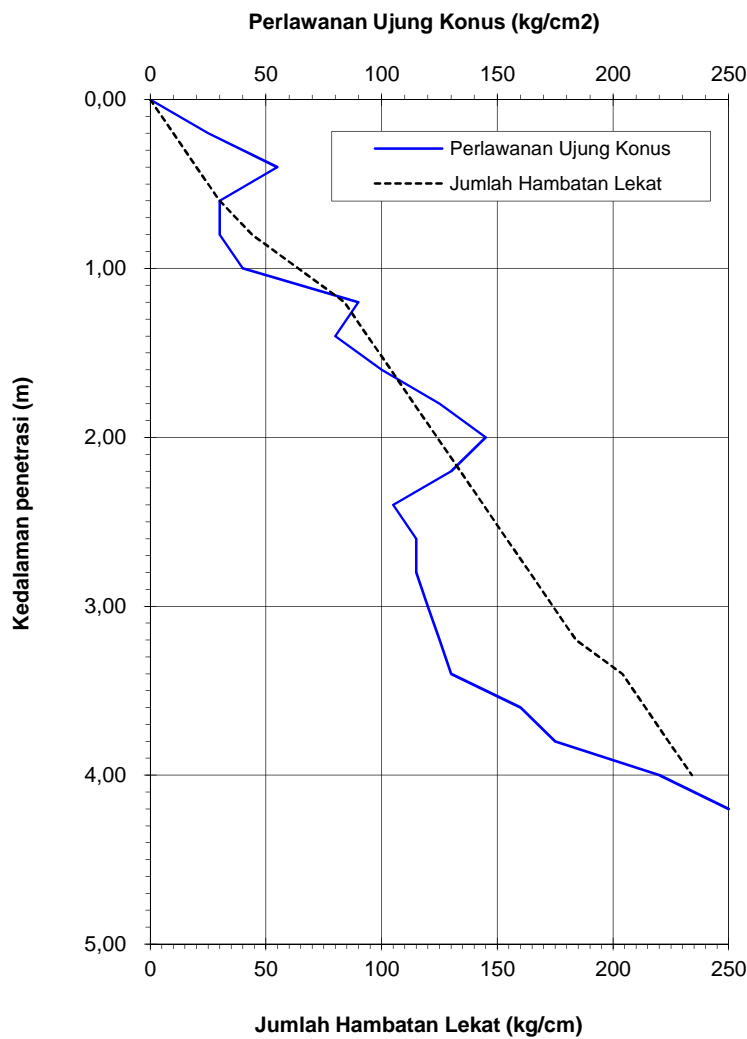

Catatan:

Titik 0 m dari permukaan tanah/ tanah dasar (tempat lokasi sondir)

Pelaksana Soil Test



: MUKA AIR TANAH ditemukan pada kedalaman - 6,00 m (sumur dekat lokasi)

(Agung Prabowo, ST., MT)

()

()

BORING LOG

BORING NO	: BH-1
SHEET	: 3 of 3
TOTAL DEPTH	: 30 m

PROJECT	: SOIL INVESTIGASI PERENCANAAN PEMBANGUNAN HOTEL LOMBOK	COMMENCEMENT DATE	: 2 Nopember 2013
LOCATION	: Jl. Jenderal Sudirman, Kota Mataram, NTB	COMPLETION DATE	: 12 Nopember 2013
COORDINATES	: X : 08° 33' 53.5" Y : 116° 07' 15.2"	DRILLER	: Mr. INUL
	DEPTH OF G.W.L : - 6.00 m	LOGGED	: Mr. Dino
GROUND ELEVATION	: - m dpl		

1	2	3	4	5	6	7	8				9	11	12	13	15				16		20							24	25						
							CORES								Field Soil Test - SPT				WATER TEST		HASIL PENGUJIAN LABORATORIUM														
DATE	SCALE	DEPTH IN METER	GWL IN METER	CORE BARREL & BIT TYPE	CASSING TYPE	DEPTH OF WATER LOSS	RUN NO.	RECOVERY in %	R.Q.D in %	ROCK UNIT	GRAPH OF R.Q.D	ROCK SYMBOL	METHOD OF SAMPLING	DESCRIPTION OF LITHOLOGY	ROCK CLASSIFICATION	SOIL CLASS (USCS)	JOINT INTERVAL (cm)	15 cm pertama	15 cm kedua	15 cm ketiga	S.P.T BLOW / 30 cm	GRAFIK NILAI N	k in cm/sec	LUGEON	Kadar Air	Berat Jenis	LL-PL	Analisa Butiran	Sudut Geser	Konsolidasi	Klasifikasi Tanah	Kuat Tekan Batuan (Hammer Test)	REMARKS		
4-Nov-13		20					10	95					20.00 - 30.00 m Lanau kepasiran/ batu lanau, plastisitas rendah s/d sedang, coklat tua, sangat padat		ML																				
		21					11	95										35	40	50	> 50														
		22					12	95																											
		23					13	95																											
		24					14	95																											
		25					15	95																											
		26					16	95																											
		27					1	95																											
		28					2	95																											
		29					3	95																											
		30					4	95																											
		30					5	95																											
		30					6	95																											
		30					7	95																											
		30					8	95																											
		30					9	95																											
		30					10	95																											
		30					11	95																											
		30																																	



**LABORATORIUM GEOTEKNIK DAN
GEODESI JURUSAN TEKNIK SIPIL
FAKULTAS TEKNIK
UNIVERSITAS MATARAM**

BOR LOG SOIL INVESTIGASI

PROYEK : SOIL INVESTIGASI
PERENCANAAN PEMBANGUNAN
HOTEL LOMBOK

LOKASI : Jl. Jenderal Sudirman, Kota
Mataram, NTB

LEGENDA

- ts : Top Soil
- tr : Alluvial Terrace Deposit
- LD : Lake Deposit
- VB : Volcanic Breccia
- YVB : Young Volcanic Deposit
- MH : Lanau Plastisitas Tinggi
- ML : Lanau Plastisitas Rendah
- CL : Lempung Lanauan
- CM : Lempung Lanauan
- SM : Pasir Lanauan
- SW : Pasir Kerikilan Gradasi Bagus
- SP : Pasir Kerikilan Gradasi Jelek
- GW : Kerikil Pasiran
- GM : Kerikil Lanauan

 : Batu Lanau

BORING LOG

BORING NO	: BH-1
SHEET	: 1 of 3
TOTAL DEPTH	: 30 m

PROJECT	: SOIL INVESTIGASI PERENCANAAN PEMBANGUNAN HOTEL LOMBOK	COMMENCEMENT DATE	: 2 Nopember 2013
LOCATION	: Jl. Jenderal Sudirman, Kota Mataram, NTB	COMPLETION DATE	: 12 Nopember 2013
COORDINATES	: X : 08° 33' 53.5" Y : 116° 07' 15.2"	DRILLER	: Mr. INUL
	DEPTH OF G.W.L : - 6.00 m	LOGGED	: Mr. Dino
GROUND ELEVATION	: - m dpl		

1	2	3	4	5	6	7	8				9	11	12	15			16		19						24	25																
							10	11	12	13				14	15	16	17	18	19	20	21	22	23	24																		
DATE	SCALE	DEPTH IN METER	GWL IN METER	CORE BARREL & BIT TYPE	CASSING TYPE	DEPTH OF WATER LOSS	RUN NO.	RECOVERY in %	R.O.D in %	ROCK UNIT	GRAPH OF R.O.D	ROCK SYMBOL	METHOD OF SAMPLING	DESCRIPTION OF LITHOLOGY	ROCK CLASSIFICATION	SOIL CLASS (USCS)	JOINT INTERVAL (cm)	15 cm pertama	15 cm kedua	15 cm ketiga	S.P.T BLOW / 30 cm	GRAFIK NILAI N	k in cm/sec	LUGEON	Kadar Air	Berat Jenis	LL-PL	Analisa Butiran	Sudut Geser	Konsolidasi	Klasifikasi Tanah	Kuat Tekan Batuan (Hammer Test)	REMARKS									
2-Nov-13	0	0	-	-	-	-	1	95						0.00 - 0.8 m Lanau kepasiran, coklat tua, plastisitas , rendah, lembab, kepadatan lembek	ML																											
							2	95											0.80 - 4.00 m Pasir kelanauan, Pasir halus, coklat tua , kepadatan agak padat, lembab	SM																						
							3	95																																		
							4	95																																		
							5	95																																		
							6	95																																		
							7	95																																		
3-Nov-13	1	1	-	-	-	-	8	95						4.00 - 5.00 m Lanau kepasiran, plastisitas rendah, coklat tua, lembab, kepadatan agak padat	ML																											
							9	95																																		
							1	95												5.00 - 6.00 m Pasir kelanauan, coklat muda, pasir kasar, kepadatan agak padat, terdapat gravel , diameter 0.475 s/d 2 cm, berupa butiran batu apung,	SM																					
							2	95												6.00 - 10.00 m Pasir kelanauan, sedikit butiran halus, Pasir halus, kepadatan lepas/ urai, hitam kecoklatan, basah	SM																					
							3	95																																		
							4	95																																		
							5	95																																		
	2	2	-	-	-	-	6	95																																		
							7	95																																		



**LABORATORIUM GEOTEKNIK DAN
GEODESI JURUSAN TEKNIK SIPIL
FAKULTAS TEKNIK
UNIVERSITAS MATARAM**

BOR LOG SOIL INVESTIGASI

PROYEK : SOIL INVESTIGASI PERENCANAAN PEMBANGUNAN HOTEL LOMBOK

LOKASI : Jl. Jenderal Sudirman, Kota Mataram, NTB

LEGENDA

- ts : Top Soil
- tr : Alluvial Terrace Deposit
- LD : Lake Deposit
- VB : Volcanic Breccia
- YVB : Young Volcanic Deposit
- MH : Lanau Plastisitas Tinggi
- ML : Lanau Plastisitas Rendah
- CL : Lempung Plastisitas Rendah
- CM : Lempung Lanauan
- SM : Pasir Lanauan
- SW : Pasir Kerikilan Gradasi Bagus
- SP : Pasir Kerikilan Gradasi Jelek
- GW : Kerikil Pasiran
- GM : Kerikil Lanauan

 : Pasir Kelanauan

 : Lanau Kepasiran

 : Lanau Kepasiran Bergravel

App.

LAMPIRAN 4

Data Hasil SAP2000 v.14

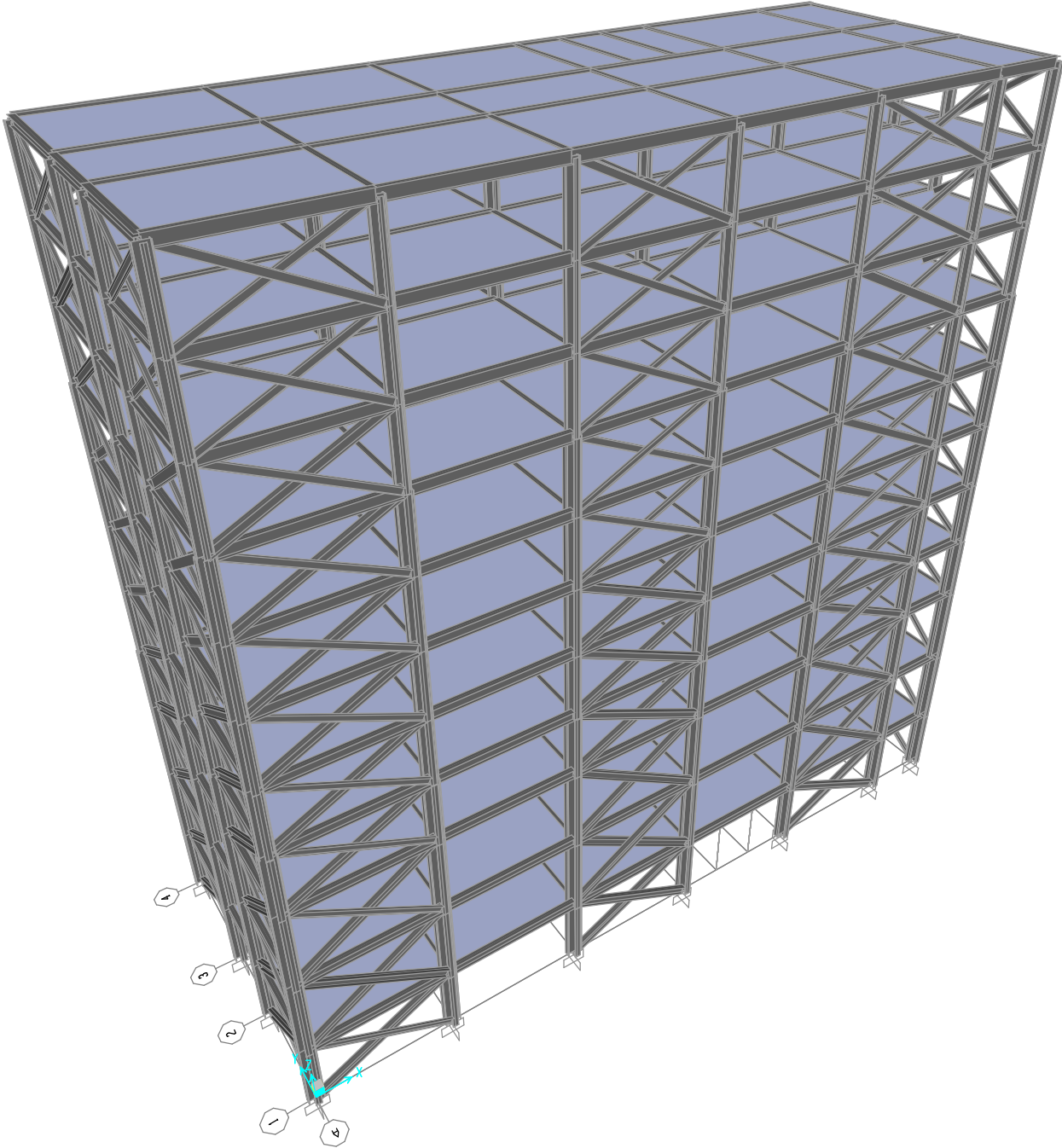

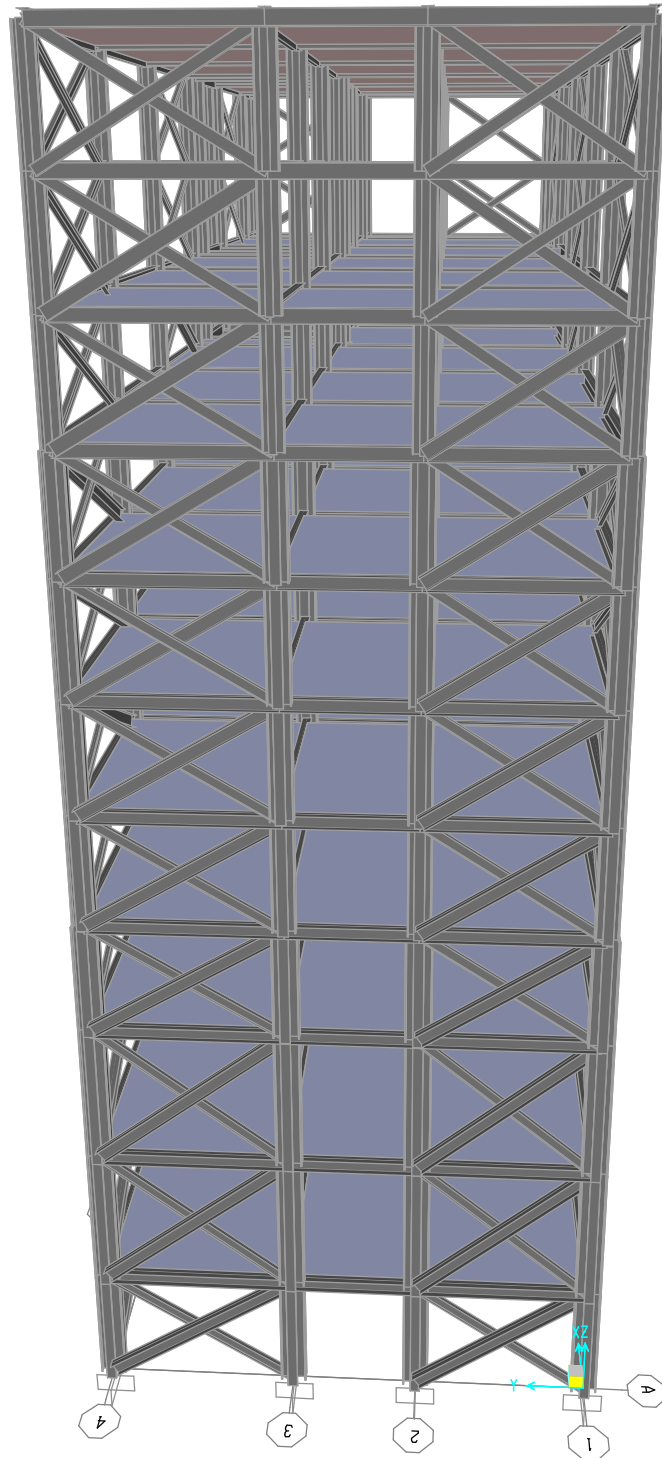

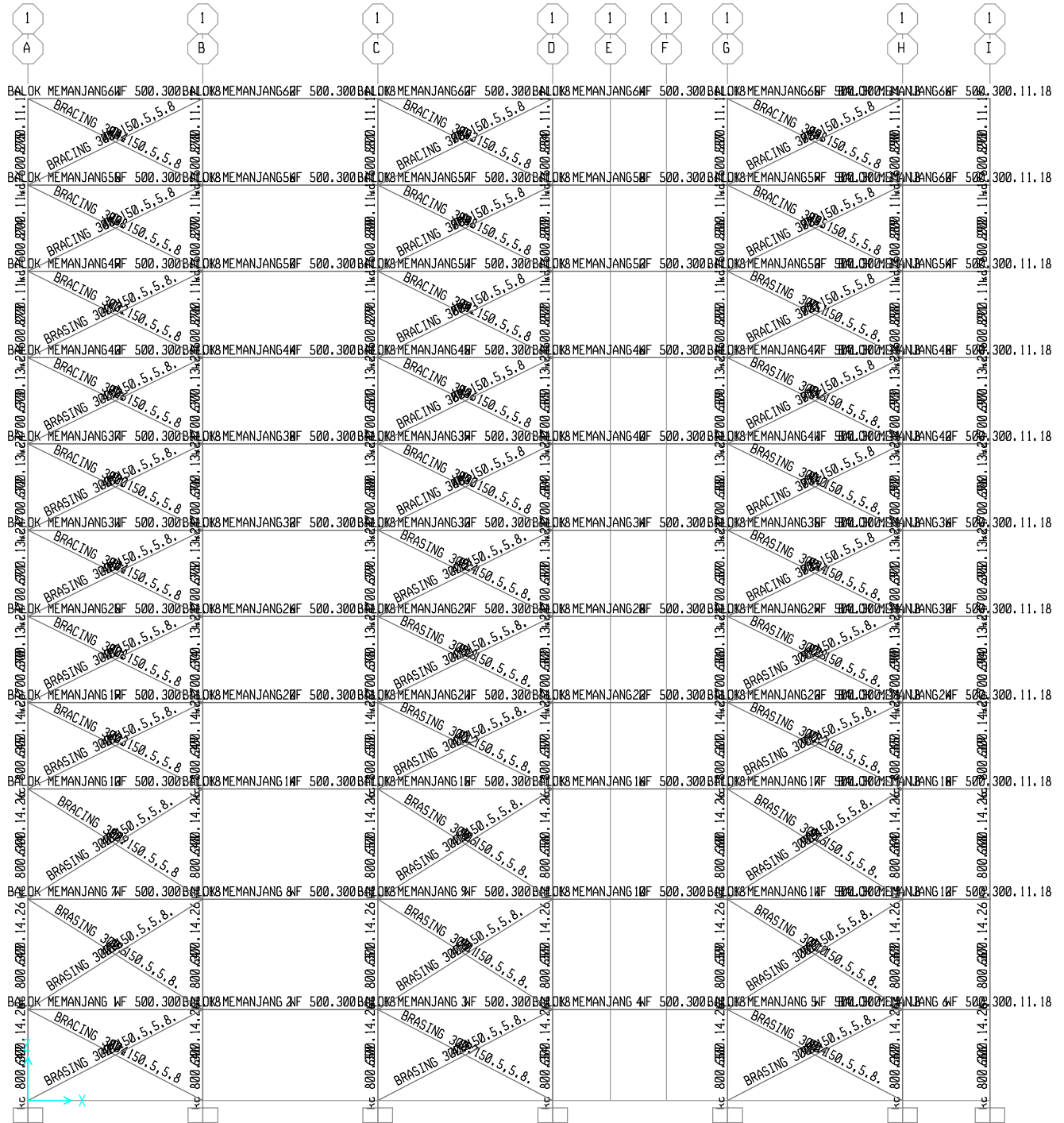

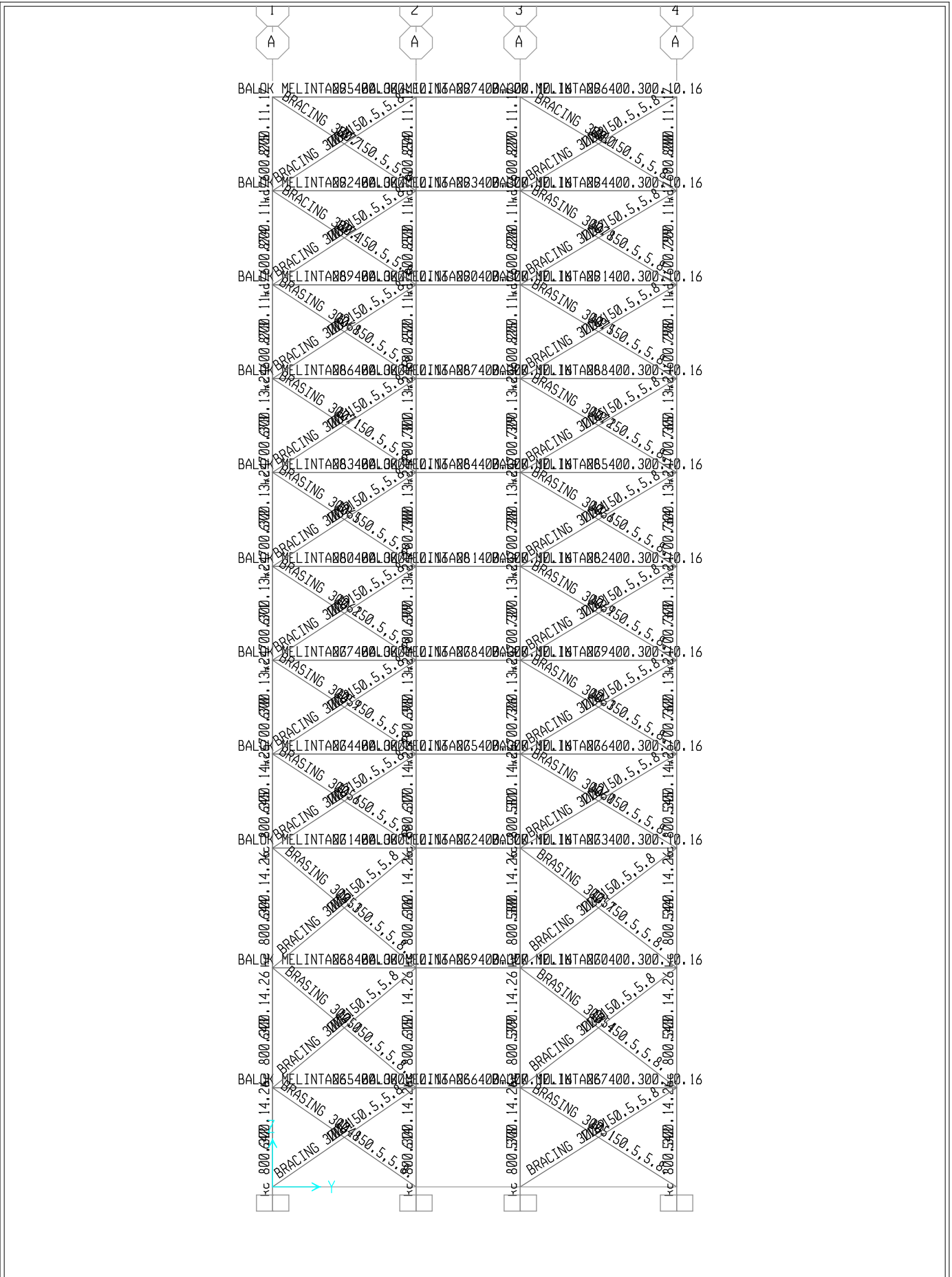

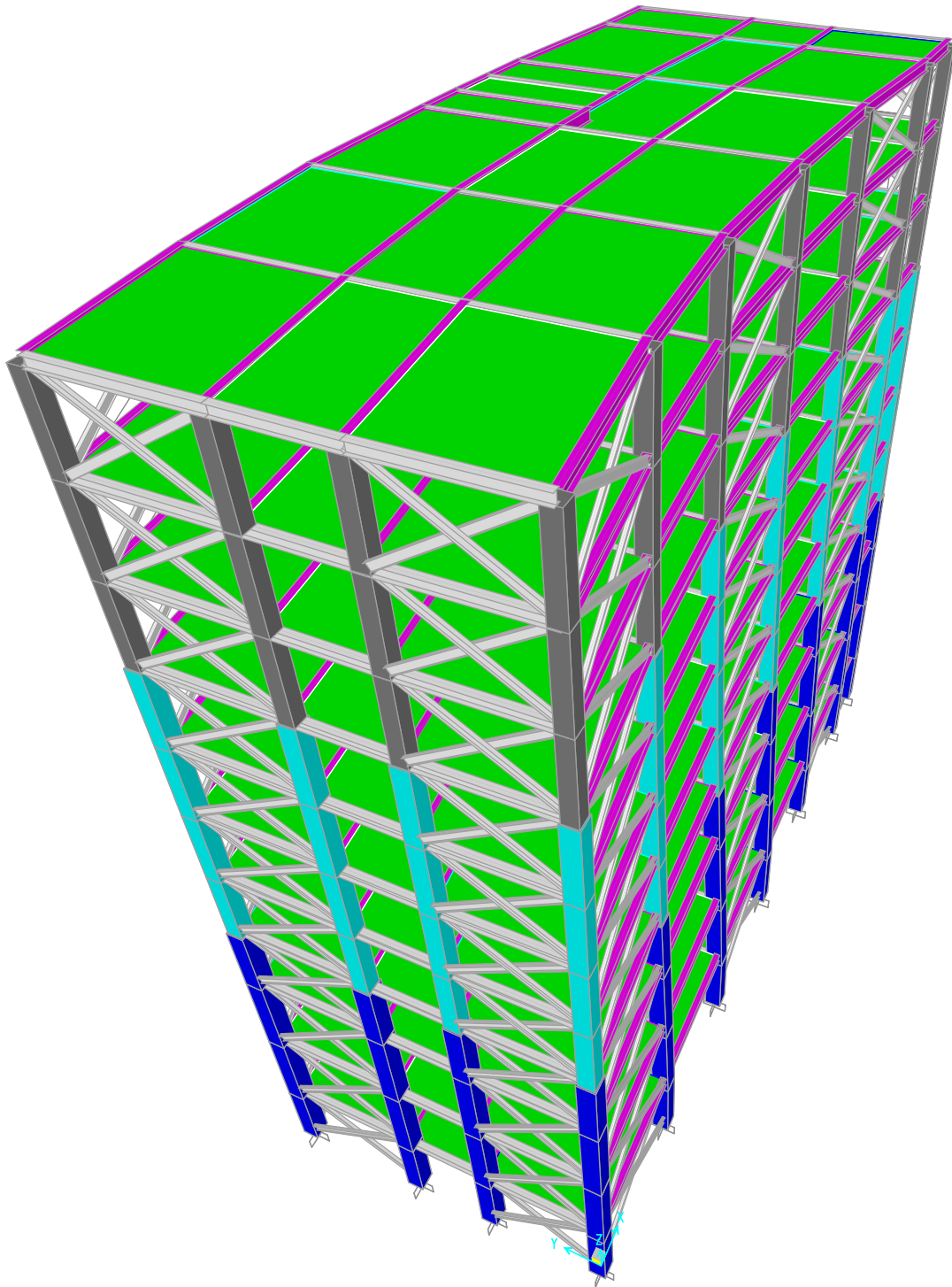

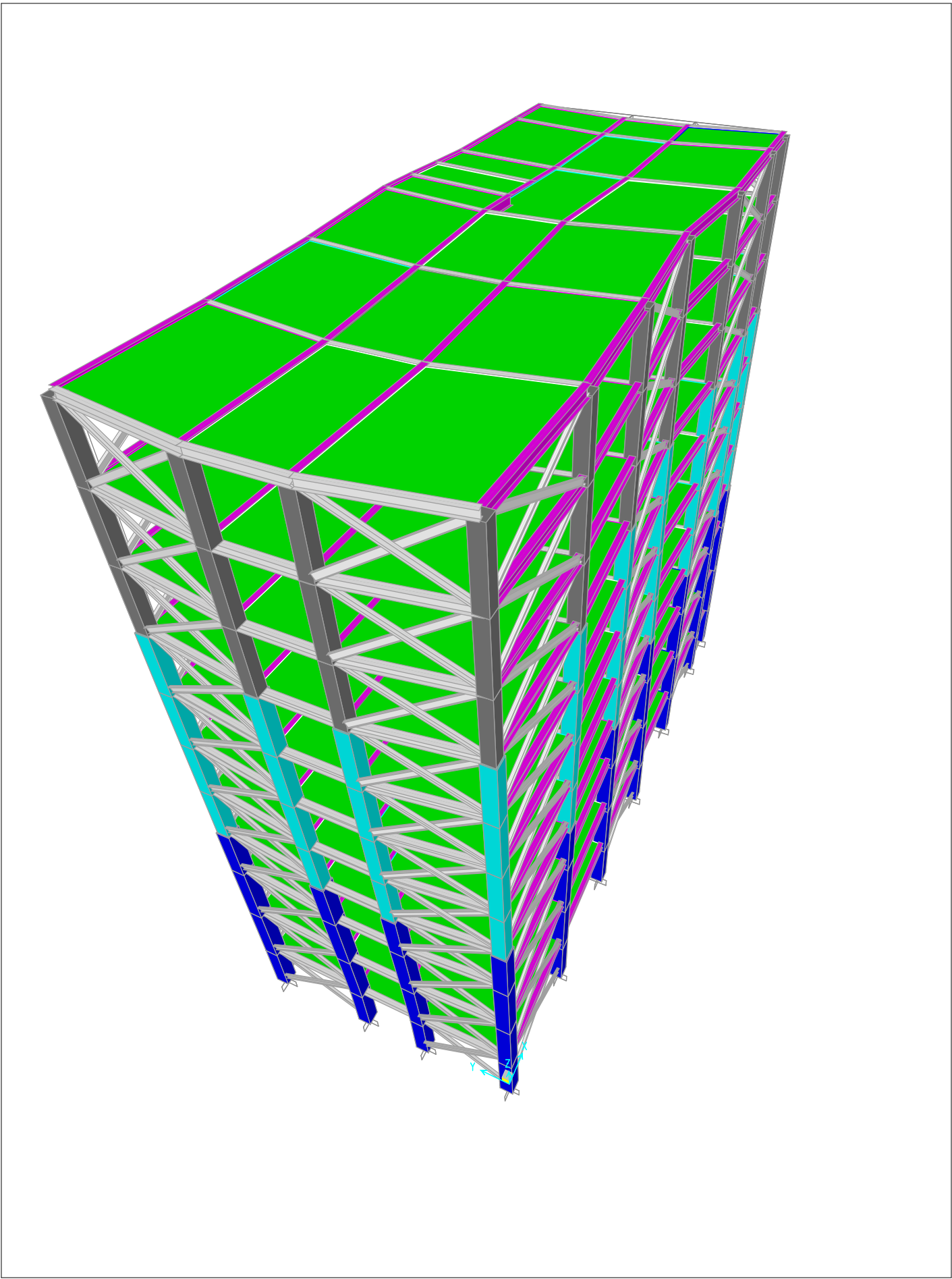

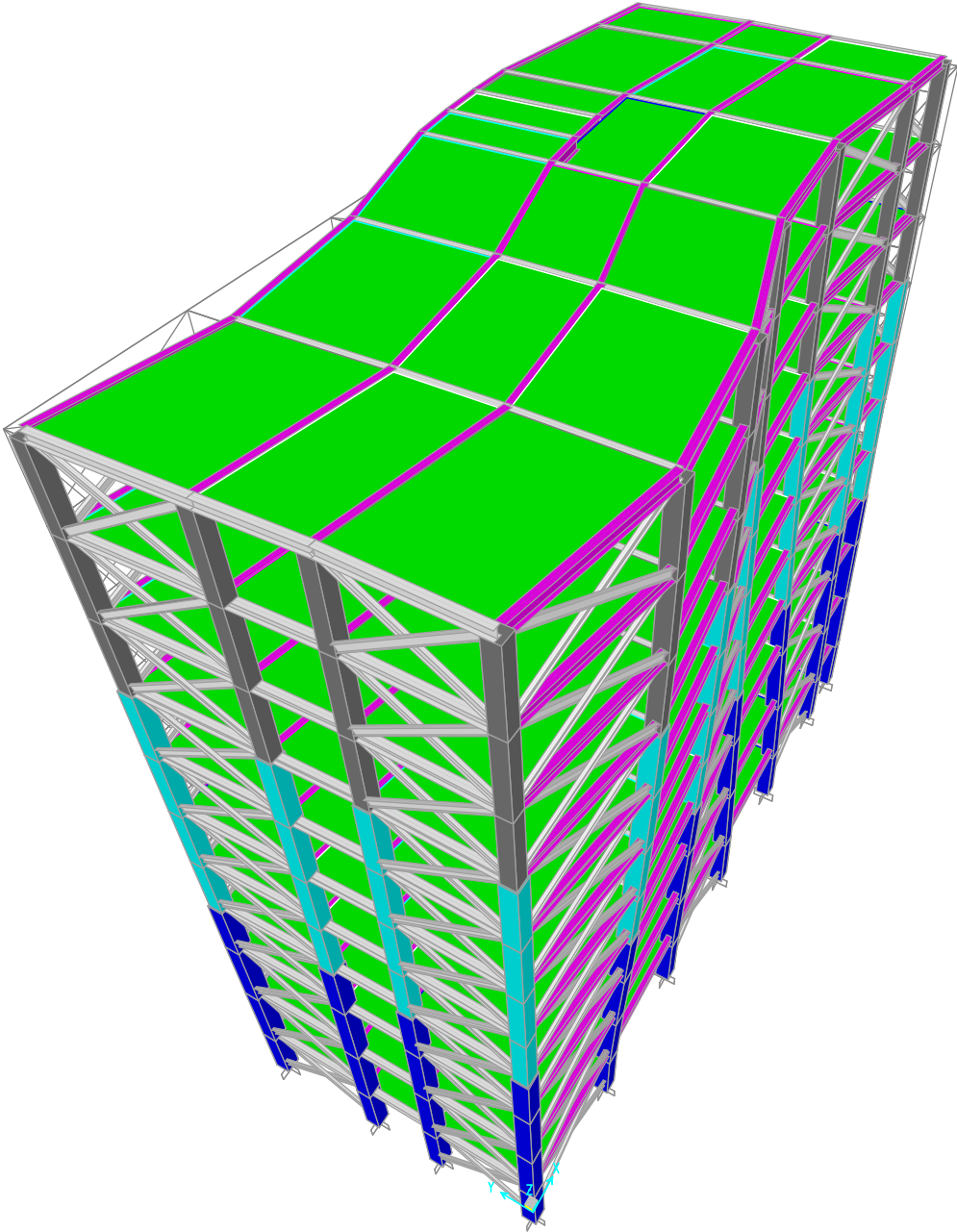

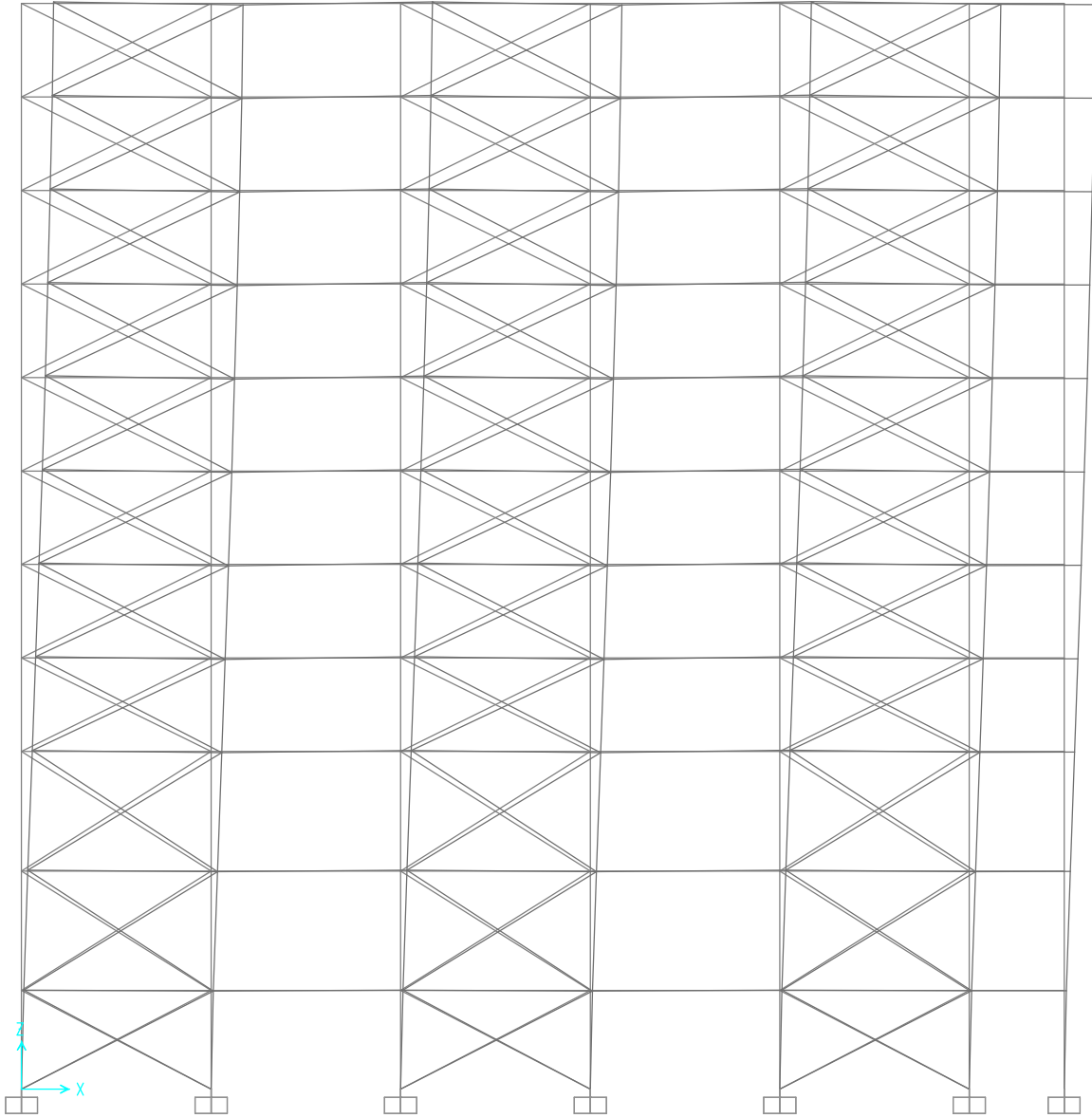

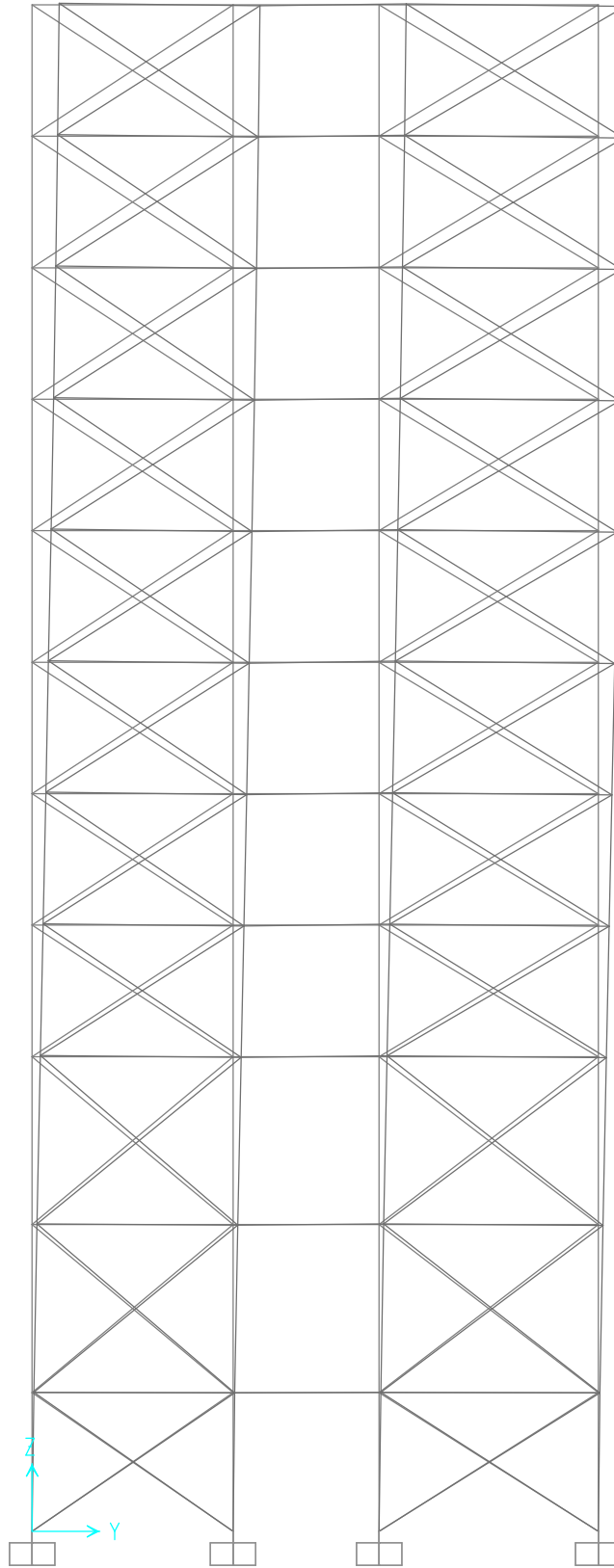

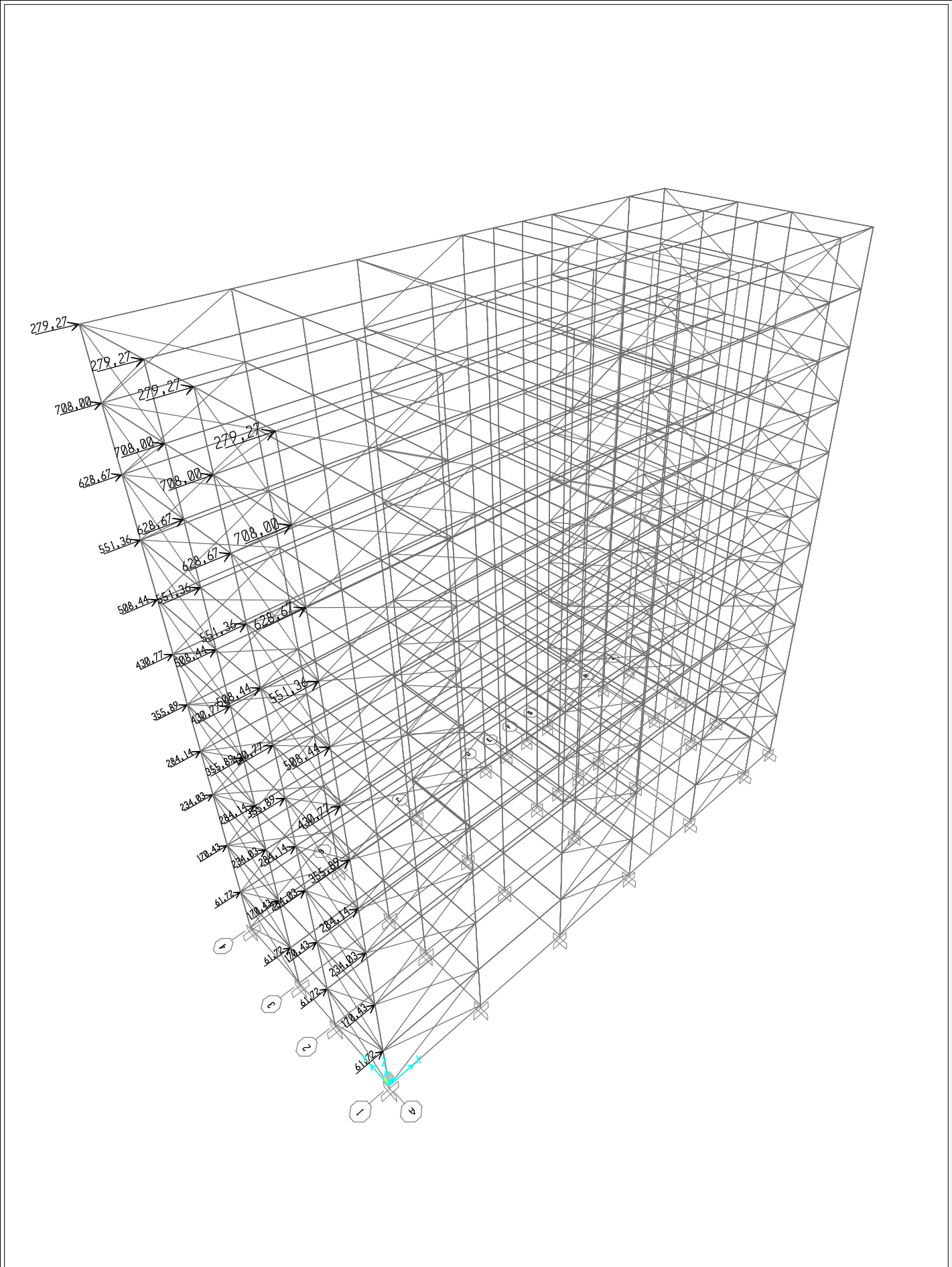

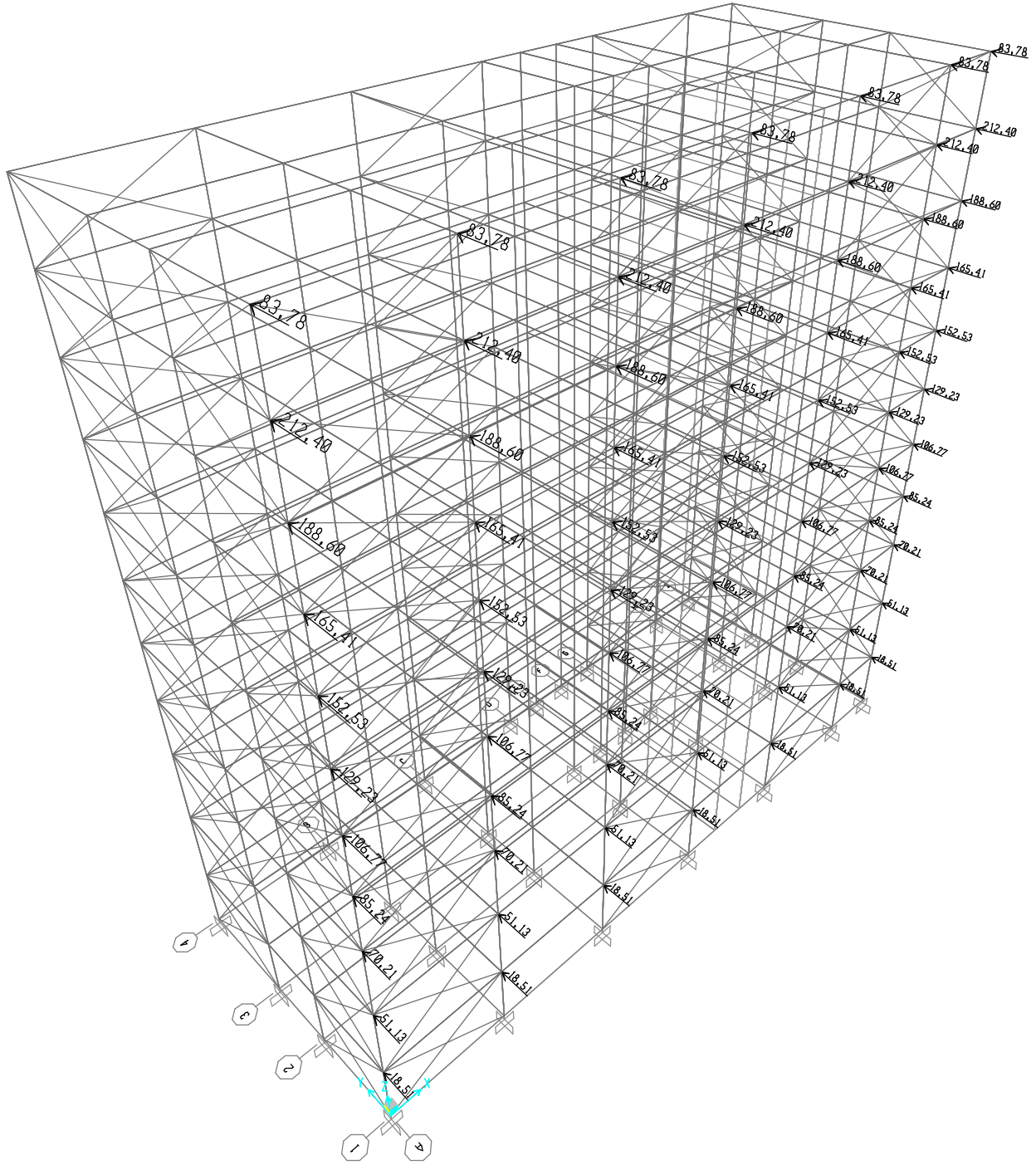

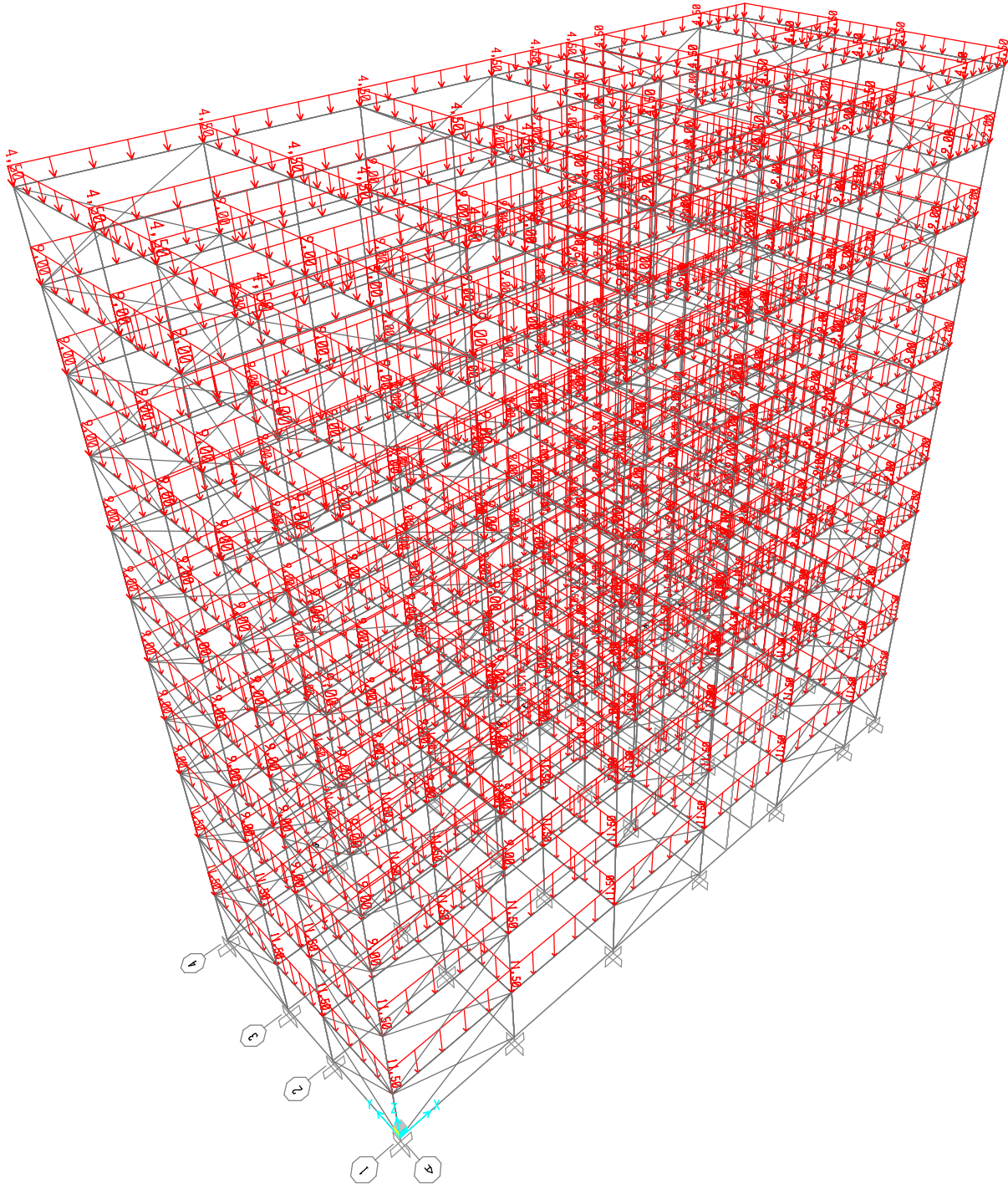

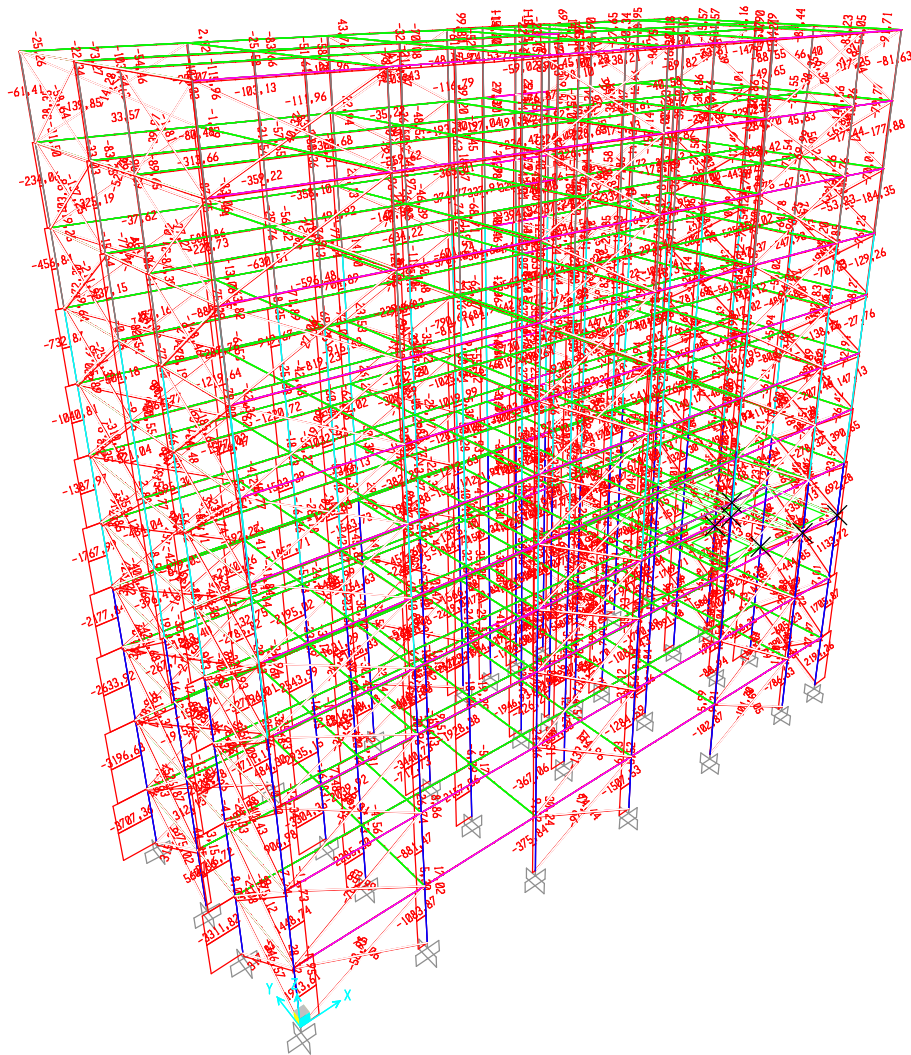

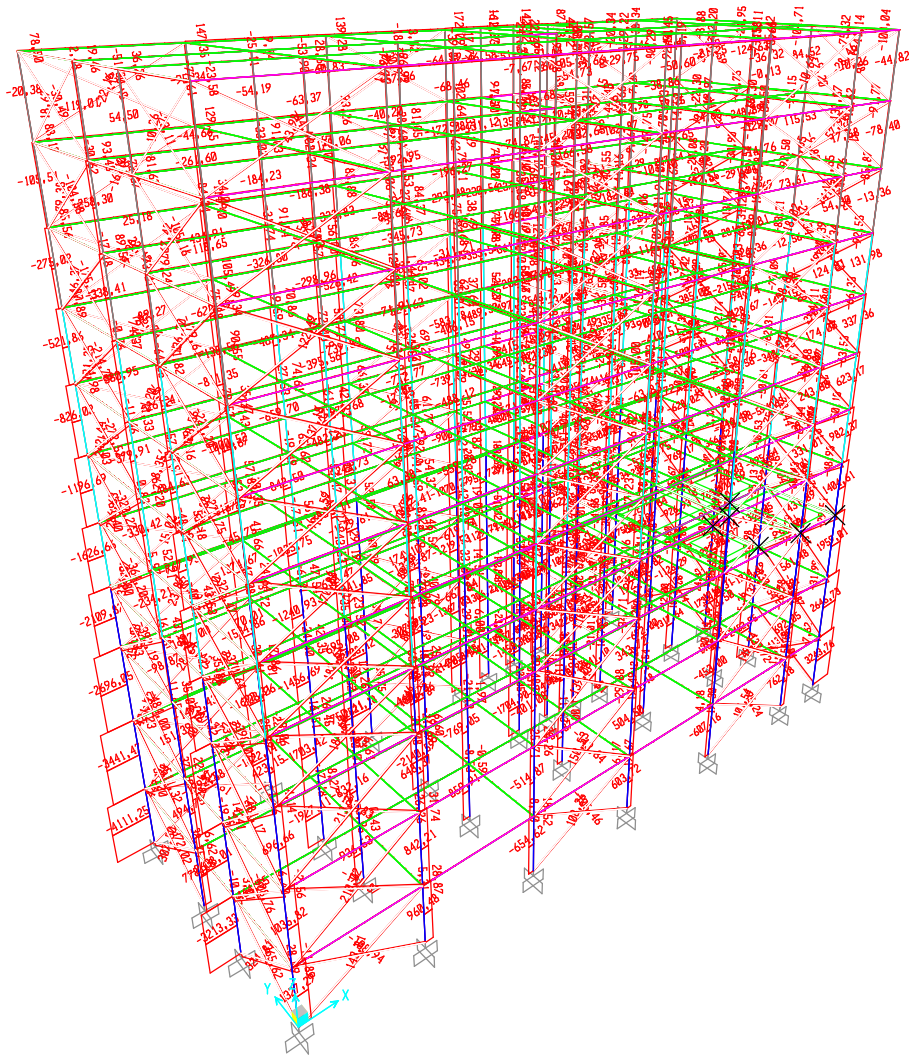

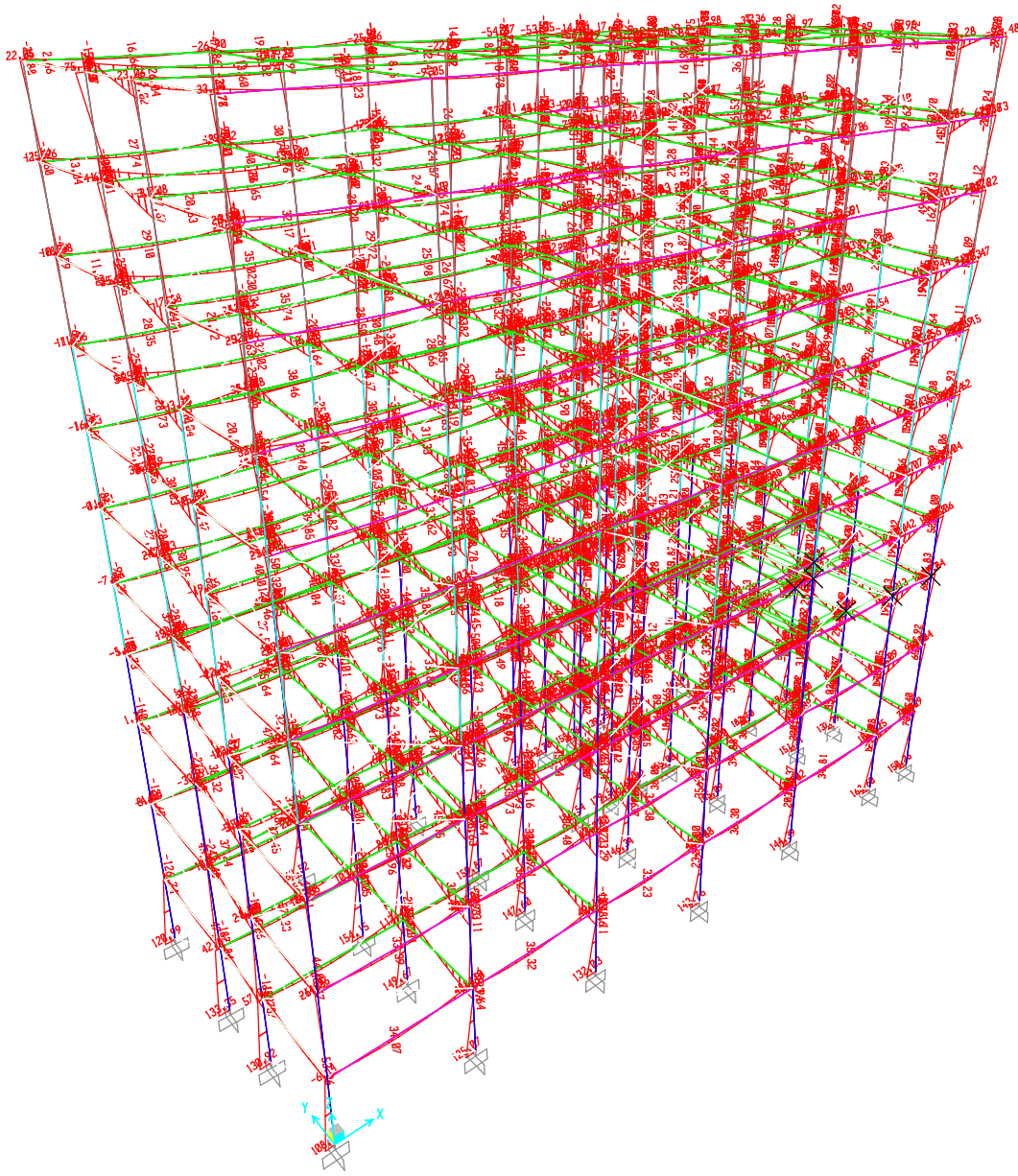

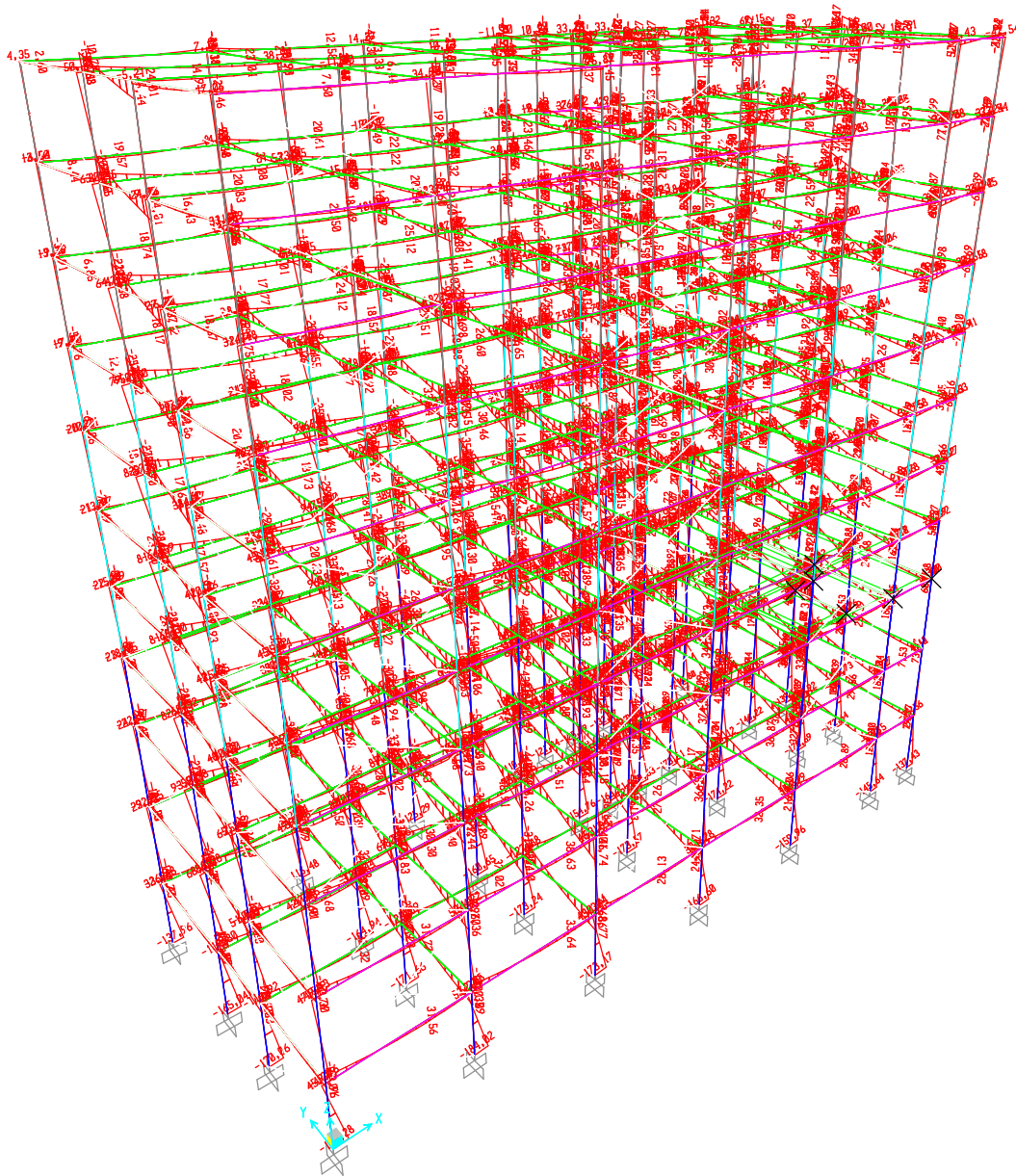

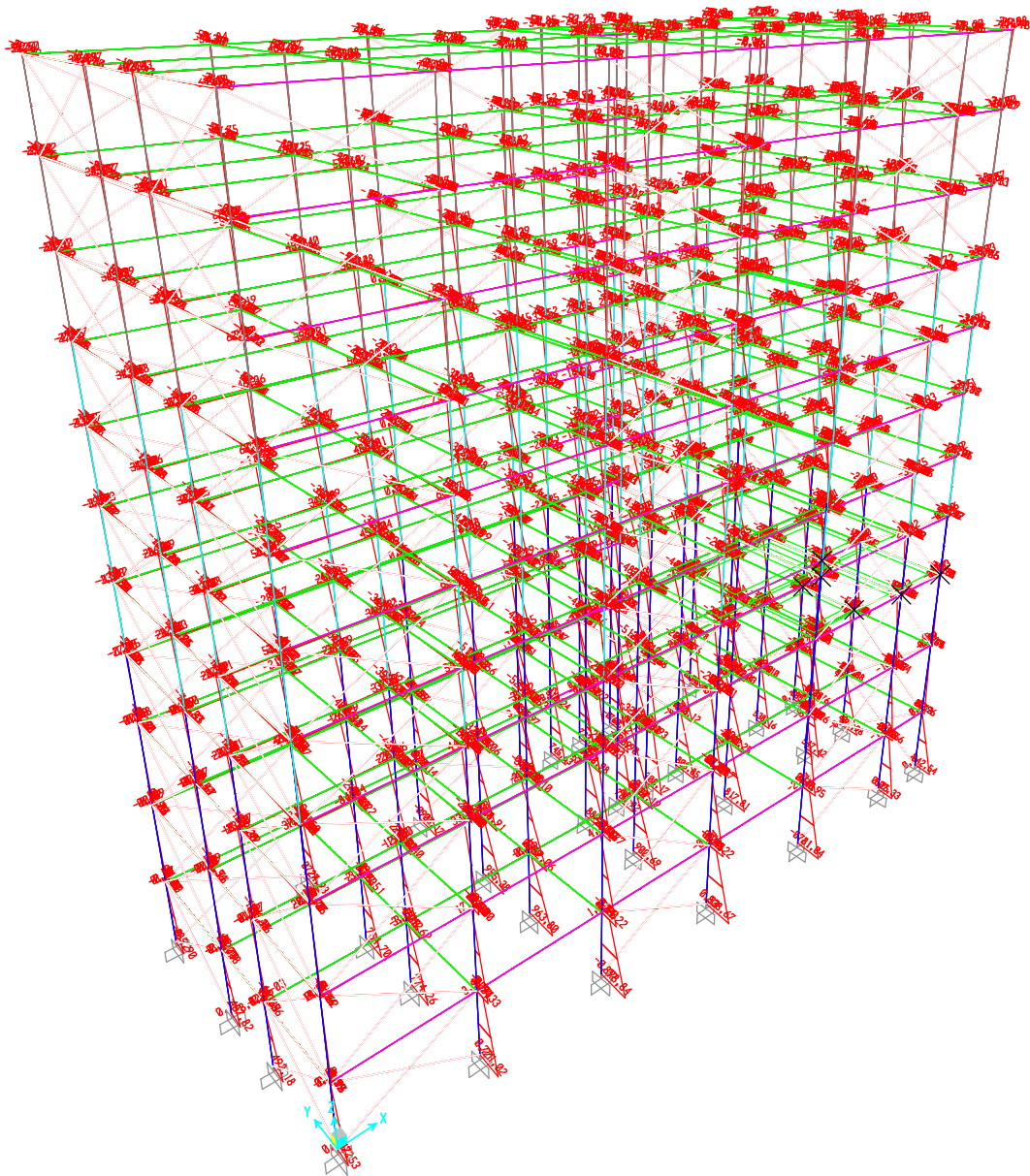

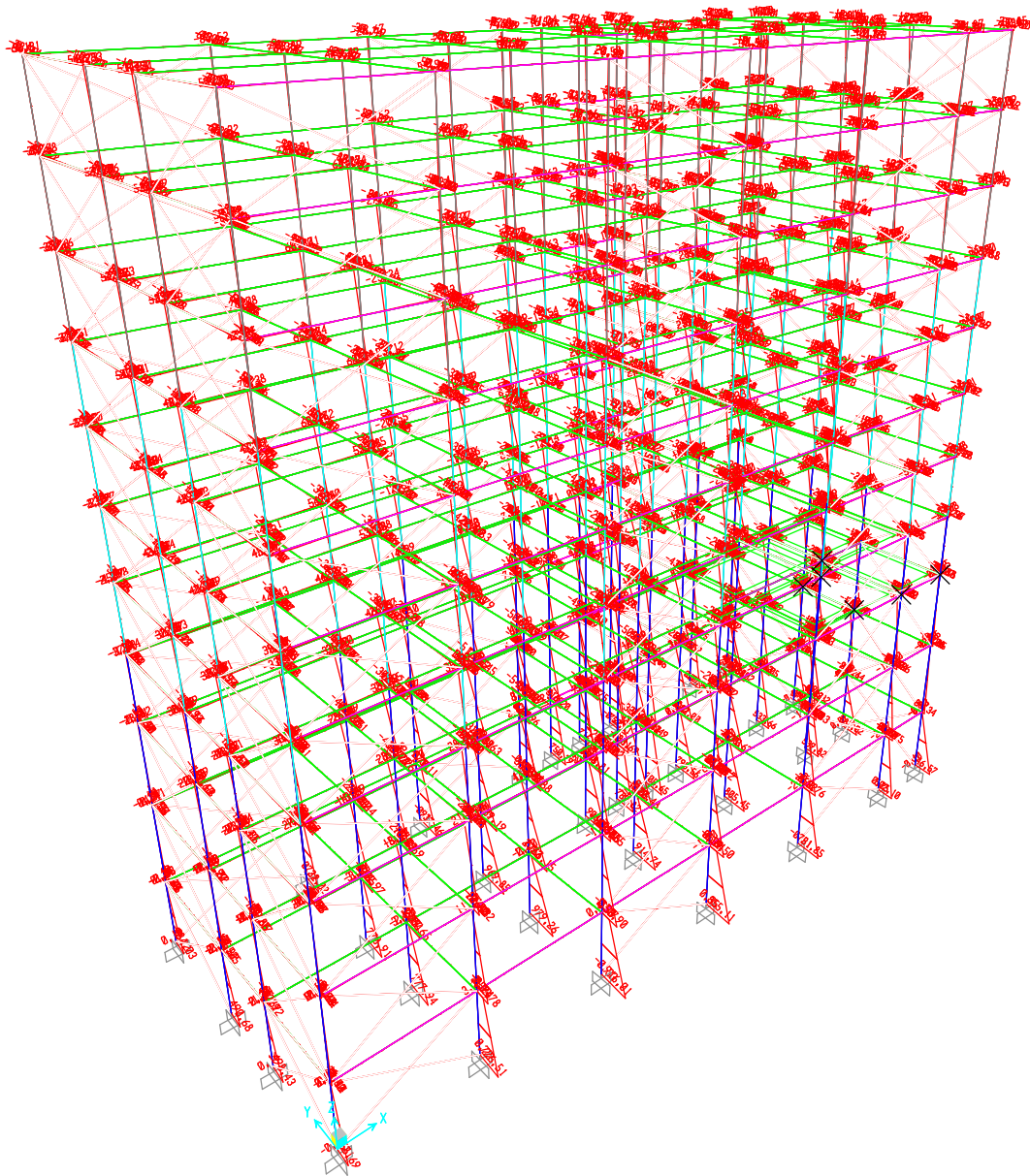

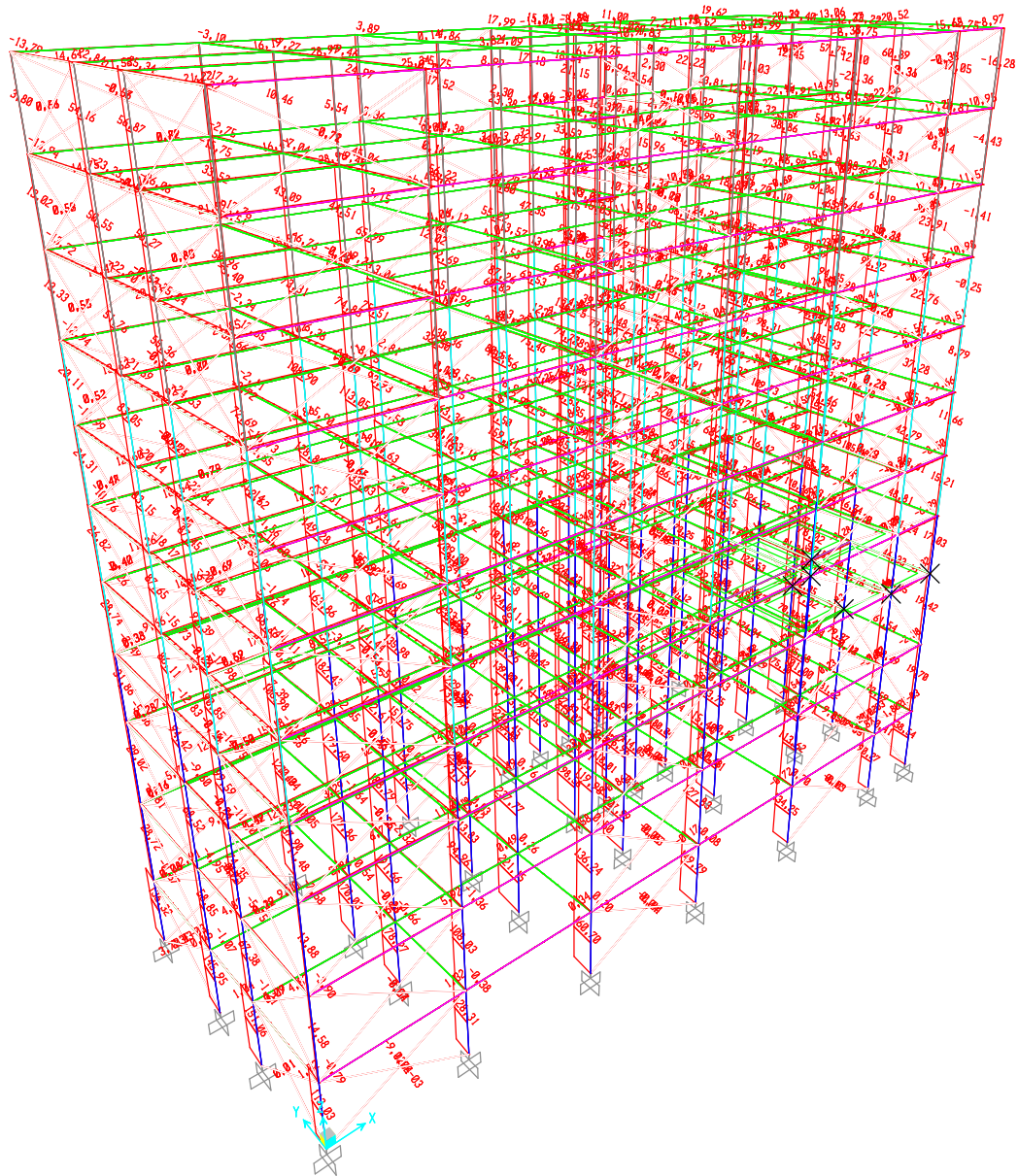

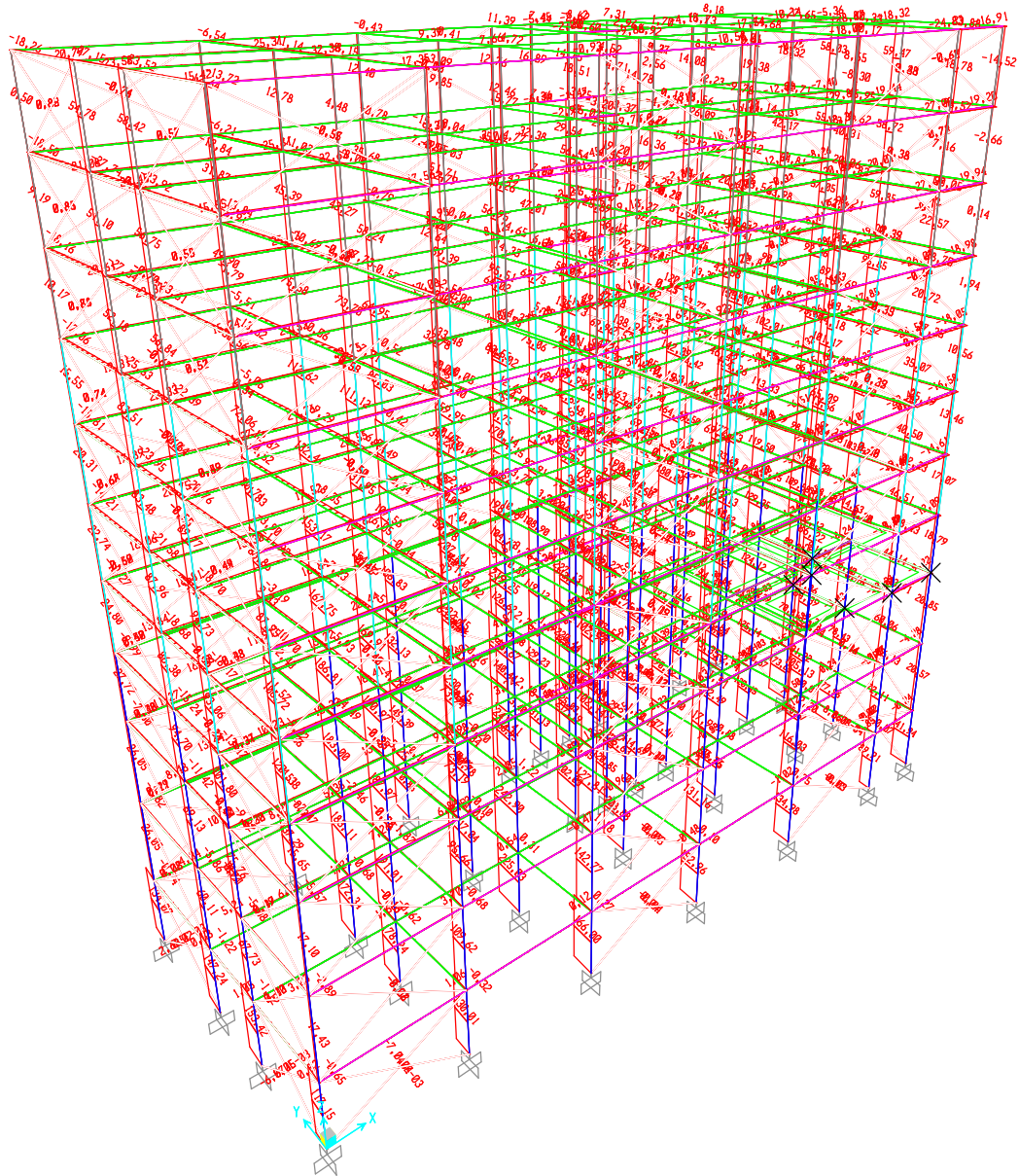

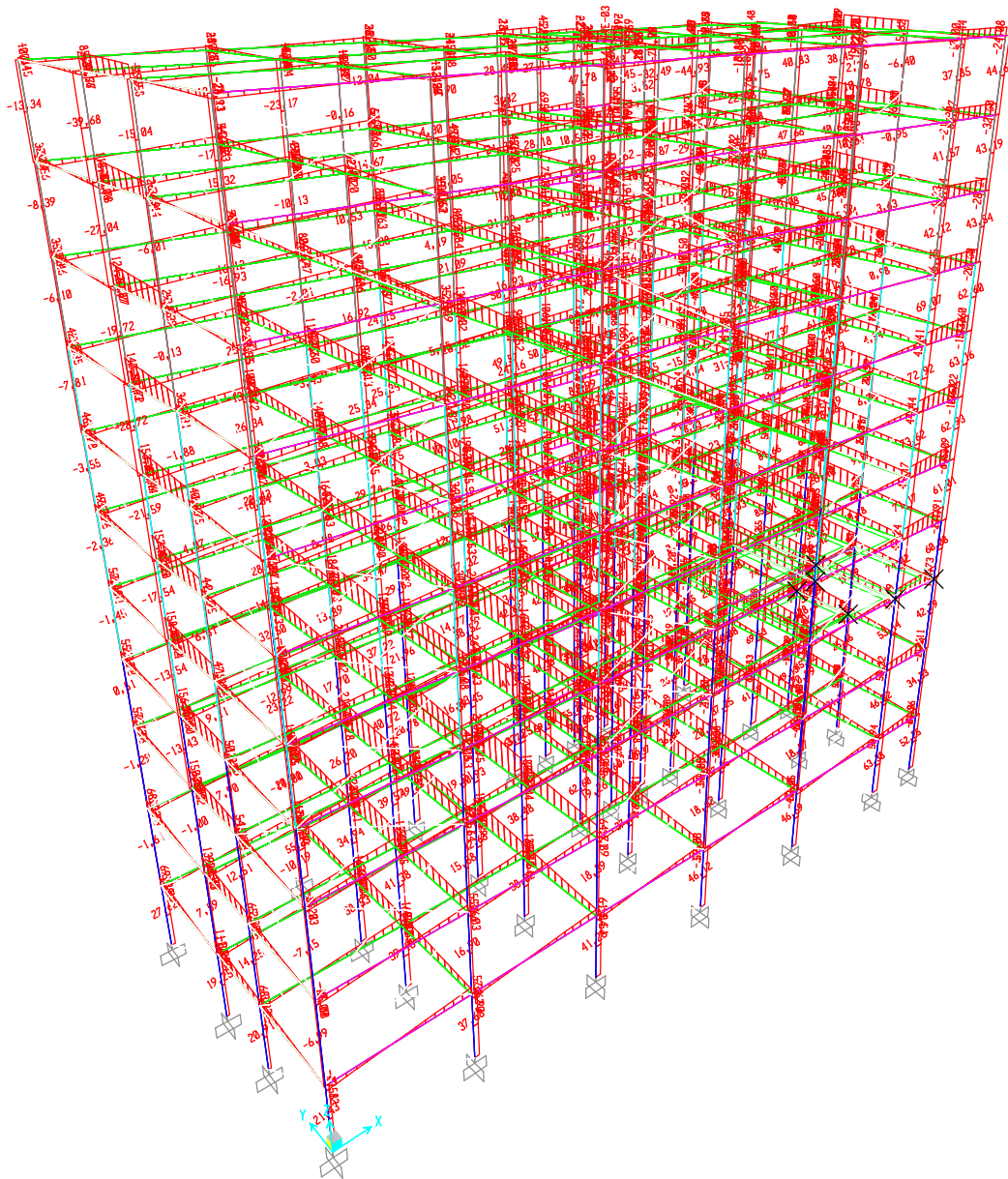

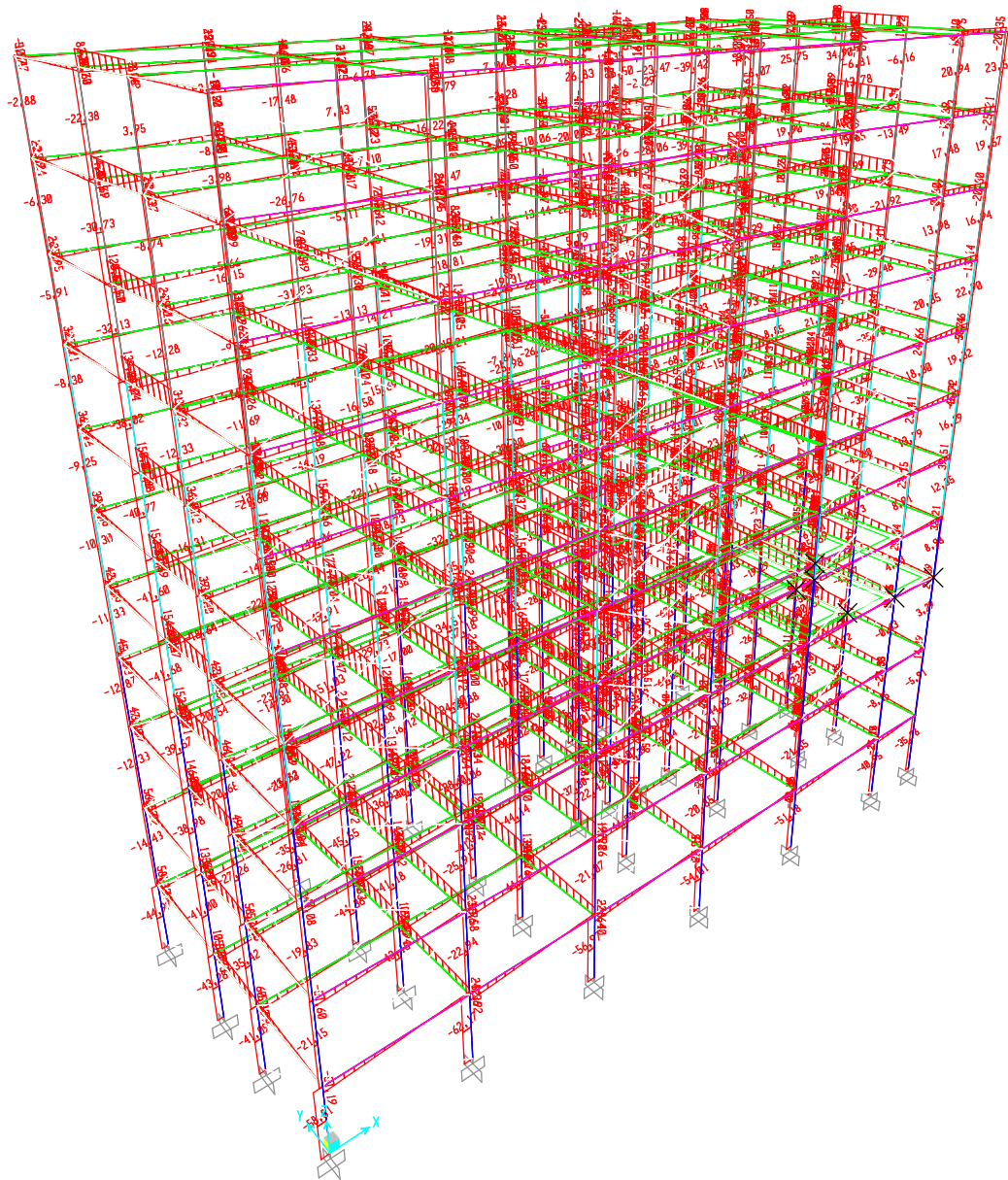

SAP200 V.14

DIAGRAM BIDANG MOMEN 3-3 BALOK

FRAME 336

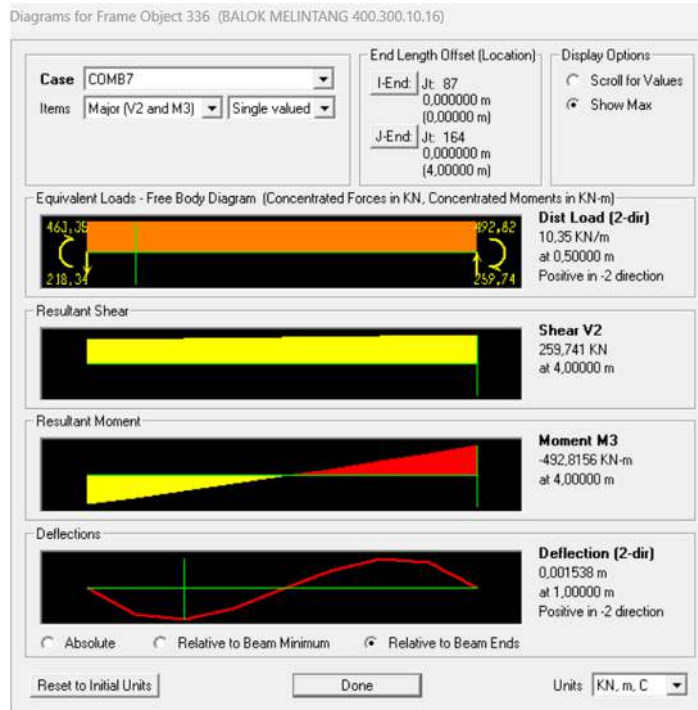

SAP200 V.14

AXIAL FORCE (PU) BRACING

FRAME 1074

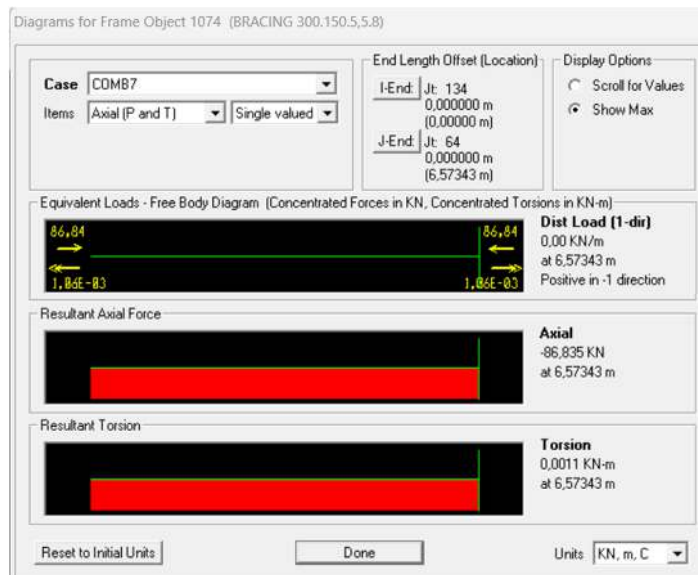

SAP200 V.14

AXIAL FORCE (PU) KOLOM

FRAME 575

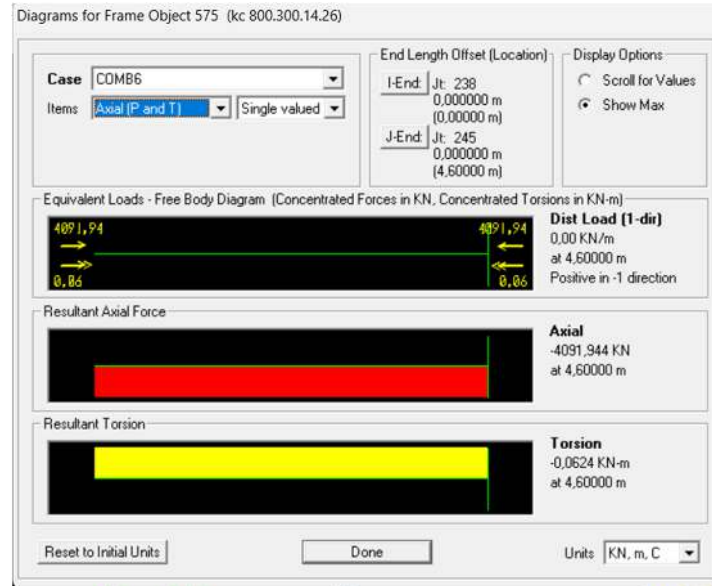

SAP200 V.14

DIAGRAM BIDANG MOMEN 3-3

FRAME 575

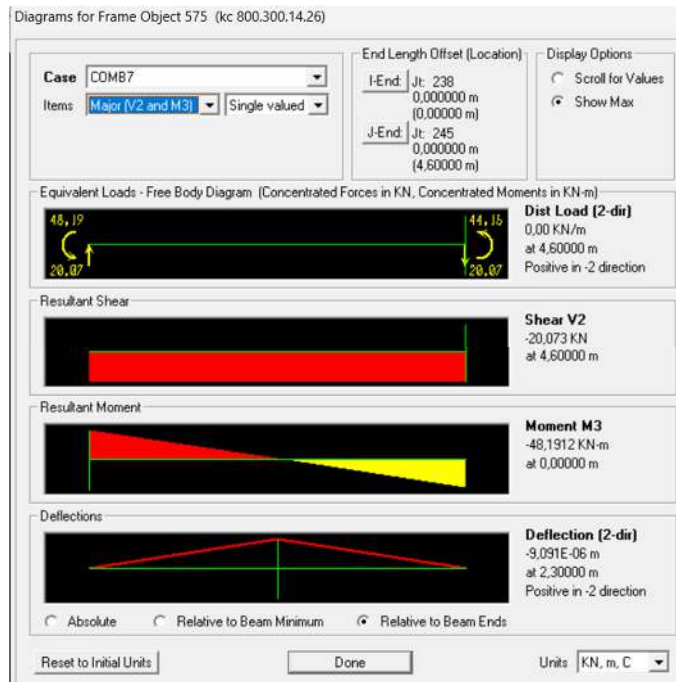

SAP200 V.14

DIAGRAM BIDANG MOMEN 2-2

FRAME 575

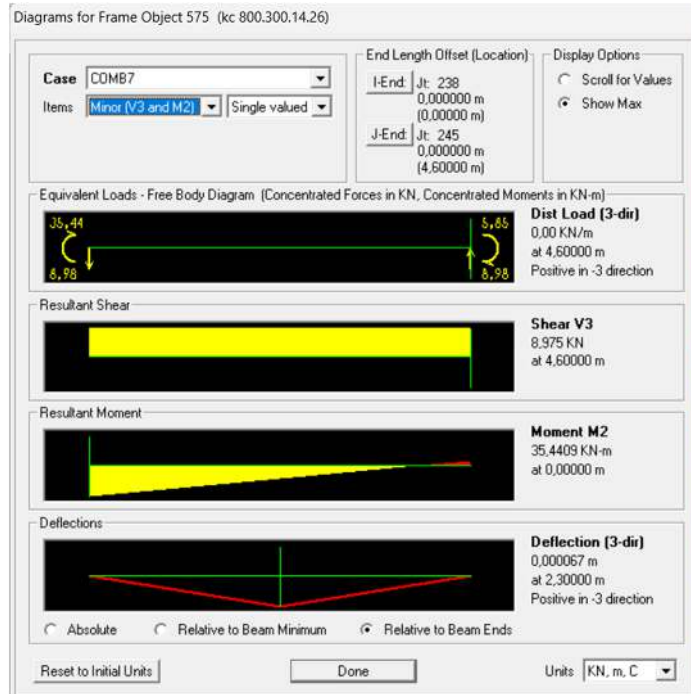

SAP200 V.14

AXIAL FORCE (PU) PONDASI

FRAME 574

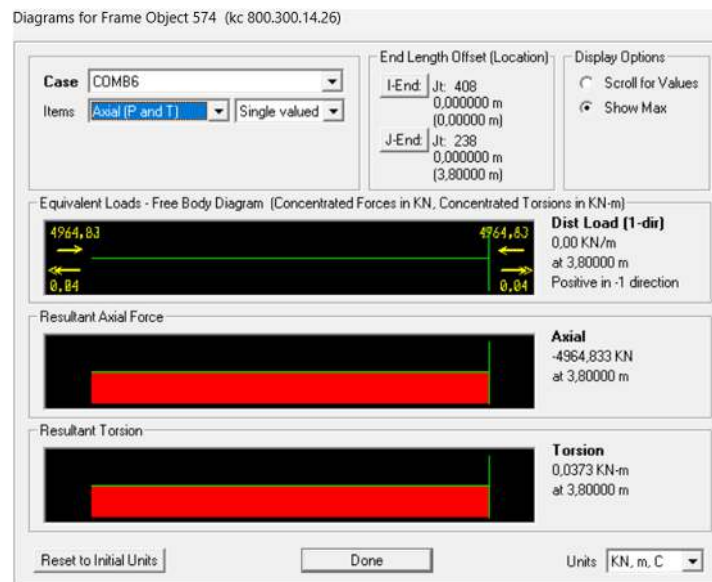

SAP200 V.14

DIAGRAM BIDANG MOMEN 2-2

FRAME 575

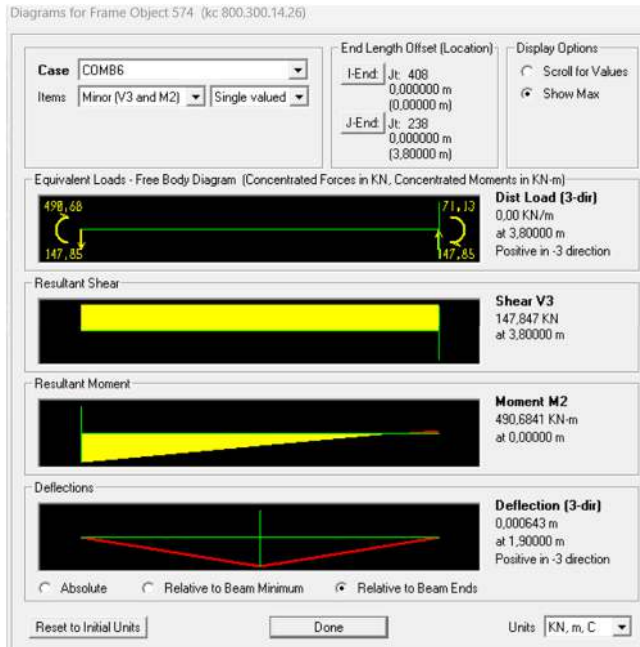

SAP200 V.14

DIAGRAM BIDANG MOMEN 3-3

FRAME 575

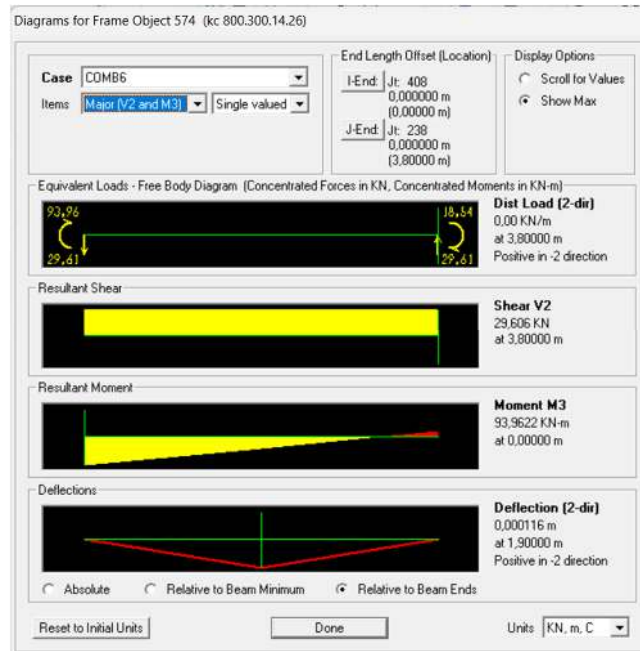

LAMPIRAN 5
Lembar Asistensi Dan Surat Lainnya



LEMBAR ASISTENSI
SKRIPSI/TUGAS AKHIR

NAMA : MASHUL WATHONI
NIM : 2019D1B081

TANGGAL	URAIAN TUGAS	PARAF
20/2023 19	- bracing pemampatan steel dgn bentuk struktur - pelajari analisis struktur perencanaan struktur baja	
14/2023 10	- penentuan struktur di bagian - least design setiap elemen struktur & cek keamanan - selanjutnya	
30/2023 10	- gambar penulangan plat lantai dipertemuan - dimensi bracing di pertemuan - sambung profil di tumpuan, cari contoh gambar sambung	

Dosen Pembimbing I

Dr. Eng. Hariyadi, ST., M.Sc (Eng)
NIDN: 0027107301



**LEMBAR ASISTENSI
SKRIPSI/TUGAS AKHIR**

NAMA : MASHUL WATHONI
NIM : 2019D1B081

TANGGAL	URAIAN TUGAS	PARAF
13/11/2023	<ul style="list-style-type: none">- Gambarkan perlu & piker ke pulanya- dimensi bracing sesuai &dimensi kolom- bedakan agar > L min- dimensi base plate harus memadai- dan itu >	
24/11/2023	<ul style="list-style-type: none">- Buat konsep- buat abstrak- siapkan gambar layout layout	
4/12/2023	<ul style="list-style-type: none">- gambar & permasalah- perbaiki sedikit abstrak- Coba buat aktual	
15/12/2023	<ul style="list-style-type: none">- Rapikan- Ace	

Dosen Pembimbing I

Dr. Eng. Hariyadi, ST., M.Sc (Eng)
NIDN: 0027107301



KEMENTERIAN RISET TEKNOLOGI DAN PENDIDIKAN TINGGI
UNIVERSITAS MUHAMMADIYAH MATARAM
FAKULTAS TEKNIK
PROGRAM STUDI TEKNIK SIPIL
Jl. K.H Ahmad Dahlan No.1 Telp. 640728 Pagesangan Mataram

LEMBAR ASISTENSI
SKRIPSI/TUGAS AKHIR

NAMA : MASHUL WATHONI
NIM : 2019D1B081

TANGGAL	URAIAN TUGAS	PARAF
24/08/ 2023	Redaksi pendahuluan diubah Tujuan penelitian & fokuskan lagi	
29/09/ 2023	Perbaiki penulisan latar belakang penubisan sitasi Redaksi penelitian terdahulu & diperbaiki	
03/10/ 2023	Persamaan dibuat menggunakan formula ditambahkan subbab JRP Bagan alir & diperbaiki	
10/10/ 2023	perbaiki bahasan subbab cara penulisan sumber dan notes	
13/10/23	Perbaiki notasi/symbol pada persamaan penulisan redaksi bagan alir	
18/10/23	Att	

Dosen Pembimbing II

Nurul Hidayati, ST., M. Eng
NIDN: 0815049401



MAJELIS PENDIDIKAN TINGGI PENELITIAN DAN PENGEMBANGAN
PIMPINAN PUSAT MUHAMMADIYAH
UNIVERSITAS MUHAMMADIYAH MATARAM
FAKULTAS TEKNIK

Alamat : Jin. K.H. Ahmad Dahlan No. 1 Telp. (0370) 633723 Mataram NTB
website : <http://fakultasteknik.ummat.ac.id>, e-mail: fatek@ummat.ac.id

Nomor : 540 /II.3.AU/FT/A/V/2023

Mataram, 21 Syawal 1444 H

Lampiran : -

11 Mei 2023 M

Prihal : Penunjukan Dosen Pembimbing Tugas Akhir/Skripsi

KEPADA YTH :

1. Dr. Eng. Hariyadi, ST.,M.Sc (Eng)
2. Nurul Hidayati, ST., M. Eng

di-

M A T A R A M

Assalamu'alaikum Warahmatullahi Wabarakatuh

Dengan hormat, sehubungan mahasiswa dibawah ini :

N A M A : Mashul Wathoni
NIM : 2019D1B081
JURUSAN/PRODI : Teknik Sipil

Telah menunjukkan Proposal Skripsi/Tugas Akhir dengan Judul "*Redesain Struktur Gedung Hotel Lombok Astoria Mataram Dengan Menggunakan Portal Baja dan Cross Bracing.*".

Maka untuk menyelesaikan Skripsi/Tugas Akhir tersebut, kami tunjuk Dosen Pembimbing sebagai berikut :

1. Pembimbing I : Dr. Eng. Hariyadi, ST.,M.Sc (Eng)
2. Pembimbing II : Nurul Hidayati, ST., M. Eng

Demikian untuk dilaksanakan sebagaimana mestinya dan atas kerjasama yang baik kami ucapkan terima kasih.

Wabillahittaufig Walhidayah.

Wassalamu'alaikum Warahmatullahi Wabarakatuh

Fakultas Teknik, UMMAT
Dekan,

Dr. H. Aji Syailendra Ubaidillah, ST., M.Sc
NIDN. 0806027101



MAJELIS PENDIDIKAN TINGGI PENELITIAN DAN PENGEMBANGAN
PIMPINAN PUSAT MUHAMMADIYAH
UNIVERSITAS MUHAMMADIYAH MATARAM
FAKULTAS TEKNIK

Alamat : Jln. K.H. Ahmad Dahlan No. 1 Telp. (0370) 633723 Mataram NTB
website : <http://fakultasteknik.ummat.ac.id>, e-mail: fatek@ummat.ac.id



SURAT-TUGAS

Nomor : 129 /IL.3.AU/FT/TGS/I/2024

Assalamu'alaikum Wr.Wb.

Yang bertanda tangan dibawah ini, Dekan Fakultas Teknik Universitas Muhammadiyah Mataram, menugaskan kepada :

N A M A : 1. Dr. Eng. Hariyadi, ST.,M.Sc (Eng)
2. Nurul Hidayati, ST.,M.Eng

Untuk menjadi penguji pada Seminar SKRIPSI/TUGAS AKHIR maha siswa dibawah ini:

- Nama : Mashul Wathoni
- N I M : 2019D1B081
- Prodi : Teknik Sipil
- Judul Skripsi : "Redesain Struktur Gedung Hotel Lombok Astoria Mataram Dengan Menggunakan Portal Baja dan Cross Bracing."

Yang akan diselenggarakan pada :

- HARI/TANGGAL : Jum'at, 26 Januari 2024
- WAKTU : PK. 15.00 - selesai
- RUANG : R. Seminar Teknik Sipil

Demikian surat tugas ini dibuat untuk dapat dilaksanakan sebaik-baiknya.

Wabillahittaufiq Walhidayah.

Wassalamu'alaikum Wr.Wb.

Mataram, 24 Januari 2024

Dekan



Dr. H. Aji Syaileendra Ubaidillah, ST., M.Sc

NIDN.0806027101



MAJELIS PENDIDIKAN TINGGI PENELITIAN DAN PENGEMBANGAN
PIMPINAN PUSAT MUHAMMADIYAH
UNIVERSITAS MUHAMMADIYAH MATARAM
FAKULTAS TEKNIK

Alamat : Jln. K.H. Ahmad Dahlan No. 1 Telp. (0370) 633723 Mataram NTB
website : <http://fakultasteknik.ummat.ac.id>, e-mail: fatek@ummat.ac.id



SURAT - TUGAS

No. \ \ / II.3.AU/FT/TGS/I/2024

Assalamu'alaikum Warahmatullahi Wabarakatuh

Yang bertanda tangan dibawah ini, Dekan Fakultas Teknik Universitas Muhammadiyah Mataram, menugaskan kepada :

N A M A : 1. Dr. Eng. Haryadi, ST., M.Eng
2. Nurul Hidayati, ST., M.Eng
3. Maya Saridewi Pascanawaty, ST., MT

Untuk menjadi penguji pada ujian **SKRIPSI/TUGAS AKHIR** mahasiswa dibawah ini :

- Nama : Mashul Wathoni
- N I M : 2019D1B081
- Prodi : Teknik Sipil
- Judul Skripsi : Redesain Struktur Gedung Hotel Lombok Astoria Mataram Dengan Menggunakan Portal Baja dan Cross Bracing.

Yang akan diselenggarakan pada :

- HARI/TANGGAL : Rabu, 31 Januari 2024
- WAKTU : pk. 10.00 - Selesai
- RUANG : R. Sidang Teknik Sipil

Demikian surat tugas ini dibuat untuk dapat dilaksanakan sebaik-baiknya.

Billahittaufiq Walhidayah

Wassalamu'alaikum Warahmatullahi Wabarakatuh

Mataram, 29 Januari 2024

Fakultas Teknik UMMAT,

Dekan,



Dr. H. Aji Syailendra Ubaidillah, ST., M.Sc

NIDN.0806027101